

Mobile Crane Grue mobile

LTM 1060-3.1

Technical Data
Caractéristiques techniques

New • Nouveau



The Lifting Professionals

Bolingbrook, IL
(630) 972-9199

South Holland, IL
(219) 972-9199

[Click Here to Request a Quote](#)



LIEBHERR

Dimensions Encombrement

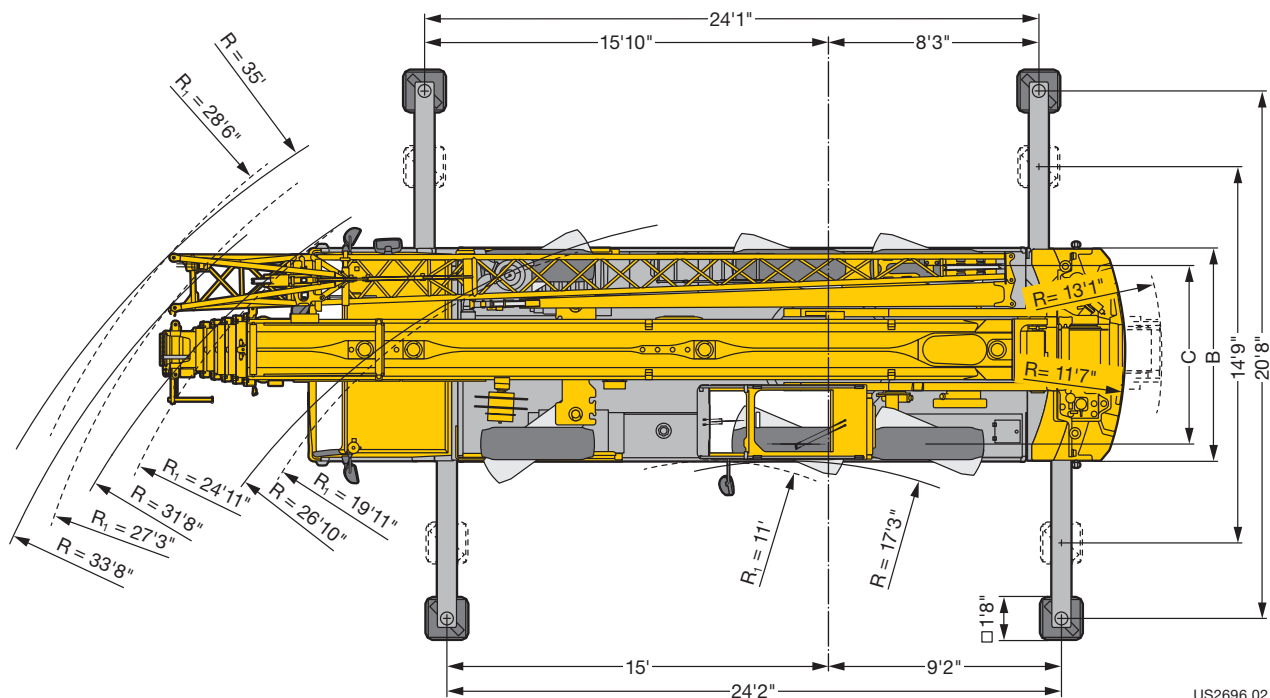
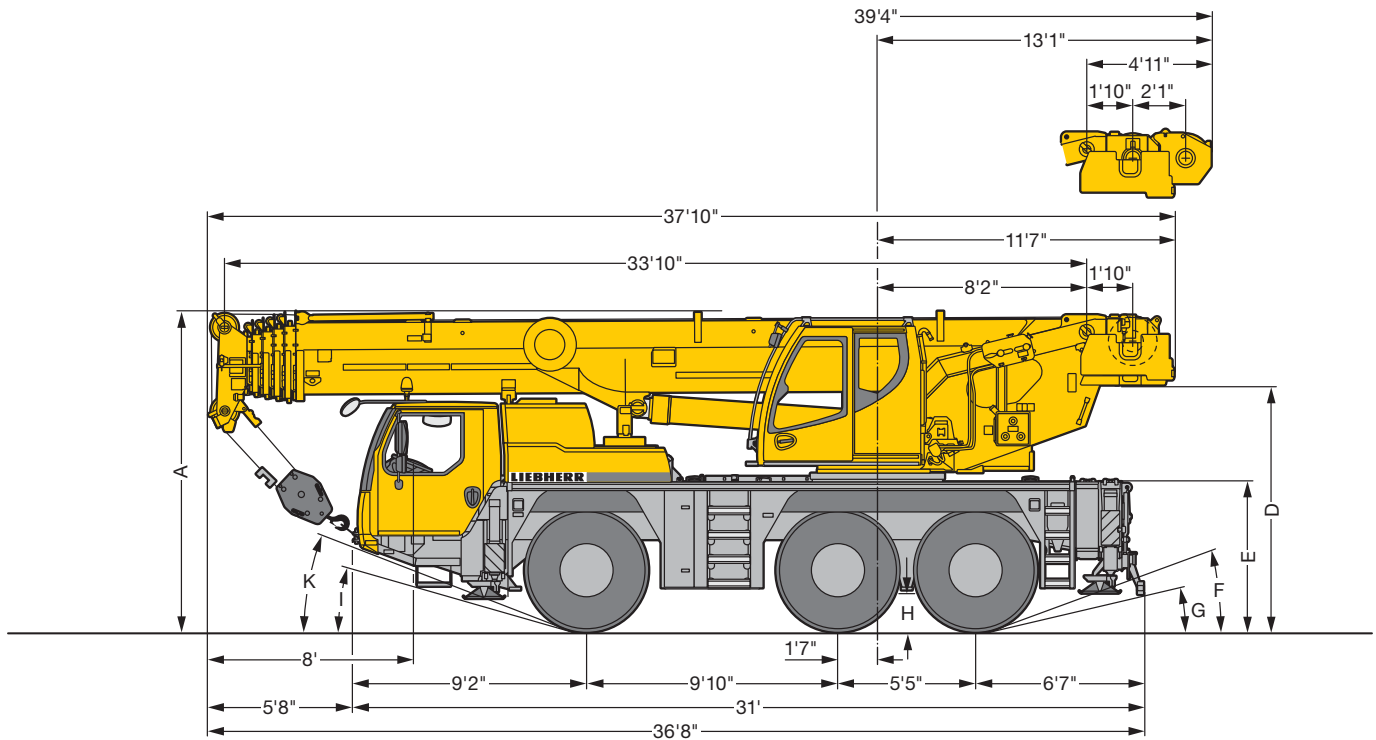

US2696.02

R₁ = All wheel steering · Direction toutes roues

	Dimensions · Encombrement										
	A	A 4" *	B	C	D	E	F	G	H	I	K
445/95 R 25 (16.00 R 25)	12'6"	12'2"	8'4"	6'11"	9'7"	5'9"	20°	12°	1'5"	15°	20°
525/80 R 25 (20.5 R 25)	12'6"	12'2"	8'10"	7'1"	9'7"	5'9"	20°	12°	1'5"	15°	20°

* lowered · abaissé

Weights Poids



Axle Essieu lbs	1	2	3	Total weight lbs Poids total lbs
	26400	26400	26400	79200 ¹⁾

¹⁾ with 12100 lbs counterweight / avec contrepoids 12100 lbs



Load kips Forces de levage kips	No. of sheaves Poulies	No. of lines Brins	Weight lbs Poids lbs
132.3	7	14	882
101.6	5	10	882
66.5	3	7	572
29.5	1	3	396
9.9	-	1	210

Working speeds Vitesses



	min.	max.	%
445/95 R 25 (16.00 R 25) 525/80 R 25 (20.5 R 25)	0.4	50	61.7 %

	12 / R2
	4 / R2



Drive Mécanismes	infinitely variable en continu	Rope diameter / Rope length Diam. du câble / Longueur du câble	Max. single line pull Effort au brin maxi.
	0 - 427 ft/min single line ft/min au brin simple	0.59" / 722 ft	10100 lbs
	0 - 427 ft/min single line ft/min au brin simple	0.59" / 722 ft	10100 lbs
	0 - 1.6 rpm		
	approx. 60 seconds to reach 82° boom angle env. 60 s jusqu'à 82°		
	approx. 330 seconds for boom extension from 34 ft - 157 ft env. 330 s pour passer de 34 ft - 157 ft		

Lifting capacities Forces de levage

T









ft	ft												ft	
	34 ft	45 ft	57 ft	68 ft	79 ft	91 ft	102 ft	113 ft	125 ft	136 ft	148 ft	157 ft		
7	132.3													7
8	129.1													8
9	124.3													9
10	119.6	93.3	91.7	89.1	75.2	65.2	50.2							10
11	113.5	93.3	92.7	89.7	75.7	65.8	50.8							11
12	106.1	93.3	91.8	89.8	76.1	66.5	51.4							12
13	99	89.8	89.2	84.6	76.6	66.7	52	41						13
14	92.5	85.3	84.6	79.7	75.4	66.3	52.5	41.4						14
15	86.5	80.9	80.3	76.2	72.3	65.9	53	41.7	32.3					15
16	81.6	76.9	76.8	73.7	69.1	65.4	53.1	42	32.6					16
17	78.3	73.2	74	70.8	67.4	64.1	53	42.1	32.8					17
18	75	69.4	70.3	69.3	65.3	61.9	52.8	42.2	33	25.6				18
19	71.8	65.7	66.7	66.8	63.5	60	52.5	42.3	33.1	25.8				19
20	68.6	62.2	63.2	63.6	61.6	58.2	52.2	42.2	33.1	26	20.6			20
22	62.1	56.1	57	57.5	57.2	54.6	51.6	41.6	33.4	26.3	20.8	15.9		22
24	54	50.4	51.5	51.9	51.7	51.1	48.3	40.6	33.3	26.5	21	16		24
26			46.7	47.1	47.3	46.7	43.9	39.3	32.8	26.7	21.2	16.2	13.5	26
28			42.2	42.8	43.7	42.5	40	37.6	32	26.6	21.3	16.4	13.6	28
30			38.3	39.6	39.9	38.9	36.7	34.5	31	26.2	21.4	16.4	13.7	30
32			34.8	36.2	36.4	35.8	33.8	32	29.9	25.7	21.1	16.4	13.8	32
34			32.1	33	33.2	32.9	31.2	30.1	28.5	25	20.8	16.3	13.8	34
36			29.4	30.2	30.4	30.1	29.1	27.9	26.8	24.3	20.4	16.1	13.8	36
38				27.8	28	27.7	27	26.2	25.5	23.5	19.9	15.8	13.8	38
40				25.7	25.9	25.6	25.2	25.2	24.1	22.7	19.3	15.6	13.6	40
45				21.5	21.6	21.3	22	21.4	21	19.8	18.2	15	13.2	45
50					18.4	19.1	18.7	18.3	18.1	17.4	17	14.3	12.8	50
55					15.9	16.5	16.2	15.8	16	15.8	14.8	13.6	12.3	55
60						14.5	14.2	14.4	14	13.8	13.3	12.8	11.8	60
65						12.8	12.6	12.7	12.3	12.3	12.1	11.3	11	65
70						11.4	11.6	11.2	11.3	10.9	10.7	9.9	9.7	70
75							10.4	10	10.1	9.7	9.3	8.7	8.6	75
80							9.3	9	9	8.6	8.3	7.7	7.6	80
85								8.2	8.1	7.7	7.4	6.8	6.8	85
90								7.4	7.3	6.9	6.6	6.1	6	90
95									6.6	6.2	5.9	5.4	5.3	95
100									6	5.6	5.3	4.8	4.8	100
105									5.4	5	4.7	4.2	4.2	105
110										4.5	4.2	3.7	3.7	110
115										4	3.7	3.2	3.2	115
120											3.3	2.8	2.8	120
125											2.9	2.4	2.4	125
130												2.1	2	130

* 0° = over rear - sur arrière

t_250_00101_00_000 / t_250_00501_00_000

Lifting capacities Forces de levage

T



34 - 157 ft



85%

ft	34 ft	45 ft	57 ft	68 ft	79 ft	91 ft	102 ft	113 ft	125 ft	136 ft	148 ft	157 ft	ft
10	93.3	91.7	89.1	75.2	65.2	50.2							10
11	93.3	92.7	89.7	75.7	65.8	50.8							11
12	93.3	93.2	89.8	76.1	66.5	51.4							12
13	93.3	92.5	84.6	76.6	66.7	52	41						13
14	92.3	87.4	79.7	75.4	66.3	52.5	41.4						14
15	86.5	82.6	76.2	72.3	65.9	53	41.7	32.3					15
16	81.6	79	73.7	69.1	65.4	53.1	42	32.6					16
17	78.3	76.3	70.8	67.4	64.1	53	42.1	32.8					17
18	75	73.5	69.7	65.3	61.9	52.8	42.2	33	25.6				18
19	71.8	70.9	67.7	63.5	60	52.5	42.3	33.1	25.8				19
20	68.5	68.5	65.9	61.6	58.2	52.2	42.2	33.1	26	20.6			20
22	62.1	63.3	61.8	58.4	54.6	51.6	41.6	33.4	26.3	20.8	15.9		22
24	54	56.2	55.8	52.6	51.1	48.3	40.6	33.3	26.5	21	16		24
26		49	49.6	47.4	46.7	43.9	39.3	32.8	26.7	21.2	16.2	13.5	26
28		43.3	43.9	44.5	42.5	40	37.6	32	26.6	21.3	16.4	13.6	28
30		38.6	39.9	40.4	38.9	36.7	34.5	31	26.2	21.4	16.4	13.7	30
32		34.8	36.3	36.5	35.8	33.8	32	29.9	25.7	21.1	16.4	13.8	32
34		32.1	33	33.2	32.9	31.2	30.1	28.5	25	20.8	16.3	13.8	34
36		29.4	30.2	30.4	30.1	29.1	27.9	26.8	24.3	20.4	16.1	13.8	36
38			27.8	28	27.7	27	26.2	25.5	23.5	19.9	15.8	13.8	38
40			25.7	25.9	25.6	25.2	25.2	24.1	22.7	19.3	15.6	13.6	40
45			21.5	21.6	21.3	22	21.4	21	19.8	18.2	15	13.2	45
50				18.4	19.1	18.7	18.3	18.1	17.4	17.1	14.3	12.8	50
55				15.9	16.5	16.2	15.8	16	15.9	15	13.6	12.3	55
60					14.5	14.2	14.4	14	13.8	13.4	12.9	11.8	60
65					12.8	12.6	12.7	12.4	12.3	12.2	11.5	11.1	65
70					11.5	11.7	11.3	11.4	11	10.8	10.1	9.9	70
75						10.5	10.2	10.2	9.8	9.5	8.9	8.8	75
80						9.5	9.1	9.1	8.8	8.5	7.9	7.8	80
85							8.4	8.3	7.9	7.6	7	7	85
90							7.6	7.5	7.1	6.8	6.3	6.2	90
95								6.8	6.4	6.1	5.6	5.5	95
100								6.1	5.7	5.5	5	5	100
105								5.6	5.1	4.9	4.4	4.4	105
110									4.6	4.4	3.9	3.9	110
115									4.2	3.9	3.4	3.4	115
120										3.5	3	3	120
125										3.1	2.6	2.6	125
130											2.2	2.2	130
135											1.9	1.9	135

t_250_00201_00_000

Lifting capacities Forces de levage

T





34 - 157 ft

85%

ft	34 ft	45 ft	57 ft	68 ft	79 ft	91 ft	102 ft	113 ft	125 ft	136 ft	148 ft	157 ft	ft
10	93.3	91.7	89.1	75.2	65.2	50.2							10
11	93.3	92.7	89.7	75.7	65.8	50.8							11
12	93	91.4	89.8	76.1	66.5	51.4							12
13	88.7	88.1	84.6	76.6	66.7	52	41						13
14	83.9	83.3	79.7	75.4	66.3	52.5	41.4						14
15	79.5	79.1	76.2	72.3	65.9	53	41.7	32.3					15
16	74.5	75.6	73.5	69.1	65.4	53.1	42	32.6					16
17	70	71	69.8	67.2	63.1	53	42.1	32.8					17
18	66	67	67.4	64.1	59.1	52.8	42.2	33	25.6				18
19	62	63.1	63.5	59.8	57.2	51.9	42.3	33.1	25.8				19
20	58.2	59.4	59.5	55.5	53.9	50.2	42.2	33.1	26	20.6			20
22	51.5	52.8	52.2	50.5	47.8	44.6	40.7	33.4	26.3	20.8	15.9		22
24	45.2	46.6	46.2	45.3	42.7	39.9	37.6	33.3	26.5	21	16		24
26		40.7	42.4	40.8	38.6	36.1	34.4	32.3	26.7	21.2	16.2	13.5	26
28		36.1	37.5	37.1	35.1	33	31.3	30.4	26.6	21.3	16.4	13.6	28
30		32.4	33.4	33.6	32	30.3	29.6	28.4	26	21.4	16.4	13.7	30
32		29.2	30.1	30.3	29.4	27.7	27.3	26.1	24.5	21.1	16.4	13.8	32
34		26.4	27.3	27.5	27	26.7	25.4	24.1	22.6	20.8	16.3	13.8	34
36		24.1	24.9	25.1	24.8	25	23.4	22.3	21.3	20.3	16.1	13.8	36
38			22.9	23	23.4	23.2	21.8	21	20.5	19.2	15.8	13.8	38
40			21	21.2	22	21.5	20.3	19.9	19.1	17.9	15.6	13.6	40
45			17.2	18.2	18.1	17.8	17.9	17.1	16.4	15.7	14.8	13.2	45
50				15.3	15.3	15.4	15.3	14.9	14.4	13.7	12.7	12.3	50
55				13.1	13.1	13.4	13	13.1	12.5	11.9	11	10.6	55
60					11.3	11.6	11.4	11.3	10.9	10.3	9.5	9.2	60
65					9.9	10.1	9.9	9.8	9.3	8.9	8.2	7.9	65
70					8.7	8.9	8.7	8.6	8.1	7.7	7.1	6.9	70
75						7.9	7.7	7.6	7.1	6.8	6.2	6	75
80						7.1	6.8	6.7	6.3	5.9	5.4	5.2	80
85							6	5.9	5.5	5.2	4.6	4.5	85
90							5.4	5.2	4.8	4.6	4	3.9	90
95								4.6	4.2	3.9	3.4	3.4	95
100								4.1	3.7	3.4	2.9	2.9	100
105								3.6	3.2	2.9	2.4	2.4	105
110									2.8	2.5	2	2	110
115									2.4	2.1			115

t_250_00507_00_000

Lifting capacities Forces de levage

T



34 - 157 ft



85%

ft	34 ft	45 ft	57 ft	68 ft	79 ft	91 ft	102 ft	113 ft	125 ft	136 ft	148 ft	157 ft	ft
10	93.3	91.7	89.1	75.2	65.2	50.2							10
11	93.3	92.7	89.7	75.7	65.8	50.8							11
12	93.3	93.2	89.8	76.1	66.5	51.4							12
13	93.3	92.5	84.6	76.6	66.7	52	41						13
14	91.7	87.4	79.7	75.4	66.3	52.5	41.4						14
15	86.5	82.6	76.2	72.3	65.9	53	41.7	32.3					15
16	81.5	79	73.6	69.1	65.4	53.1	42	32.6					16
17	77.3	76.2	70.8	67.2	63.1	53	42.1	32.8					17
18	72.9	72.9	68.4	64.1	59.1	52.8	42.2	33	25.6				18
19	68.3	68	63.8	59.8	57.2	51.9	42.3	33.1	25.8				19
20	63.6	63.1	59.6	55.5	53.9	50.2	42.2	33.1	26	20.6			20
22	53.1	54.7	52.2	50.5	47.8	44.6	40.7	33.4	26.3	20.8	15.9		22
24	45.3	46.8	46.2	45.3	42.7	39.9	37.6	33.3	26.5	21	16		24
26		40.7	42.4	40.8	38.6	36.1	34.4	32.3	26.7	21.2	16.2	13.5	26
28		36.1	37.5	37.1	35.1	33	31.4	30.4	26.6	21.3	16.4	13.6	28
30		32.4	33.4	33.6	32	30.3	29.6	28.5	26.1	21.4	16.4	13.7	30
32		29.2	30.1	30.3	29.4	27.8	27.4	26.3	24.8	21.1	16.4	13.8	32
34		26.4	27.3	27.5	27.1	26.7	25.6	24.4	23	20.8	16.3	13.8	34
36		24.1	24.9	25.1	24.8	25.1	23.8	22.7	21.3	20.4	16.1	13.8	36
38			22.9	23	23.4	23.4	22.2	21.1	20.5	19.5	15.8	13.8	38
40			21.1	21.2	22	21.7	20.7	20.2	19.5	18.3	15.6	13.6	40
45			17.5	18.3	18.3	18	17.9	17.5	16.7	15.8	15	13.2	45
50				15.6	15.6	15.4	15.6	15.1	14.7	14.2	13.3	12.5	50
55				13.5	13.4	13.7	13.4	13.4	13	12.4	11.5	11.1	55
60					11.7	11.9	11.7	11.7	11.3	10.9	10	9.7	60
65					10.3	10.5	10.3	10.2	9.8	9.4	8.7	8.4	65
70					9.1	9.3	9.1	9	8.5	8.2	7.6	7.4	70
75						8.3	8.1	8	7.5	7.2	6.6	6.5	75
80						7.4	7.2	7.1	6.7	6.3	5.8	5.7	80
85							6.4	6.3	5.9	5.6	5.1	5	85
90							5.7	5.6	5.2	5	4.4	4.3	90
95								5	4.6	4.3	3.8	3.8	95
100								4.5	4	3.8	3.3	3.3	100
105								4	3.6	3.3	2.8	2.8	105
110									3.1	2.8	2.4	2.4	110
115									2.7	2.4	2	2	115
120										2.1			120

t_250_00207_00_000

Lifting capacities Forces de levage

T





34 - 157 ft
 360°
 12100 lbs
85%

	34 ft	45 ft	57 ft	68 ft	79 ft	91 ft	102 ft	113 ft	125 ft	136 ft	148 ft	157 ft	
10	93.3	91.7	89.1	75.2	65.2	50.2							10
11	93.3	92.7	89.7	75.7	65.8	50.8							11
12	92.4	91.1	89.8	76.1	66.5	51.4							12
13	88	87.2	84.6	76.6	66.7	52	41						13
14	82.9	81.9	79.4	74.9	66.3	52.5	41.4						14
15	77.4	77.4	74.3	70.2	65.9	53	41.7	32.3					15
16	72.5	73.5	70.1	67.5	61.7	53.1	42	32.6					16
17	67.9	69	66.2	62	58.9	52.5	42.1	32.8					17
18	63.4	64.5	61.9	57.4	55.3	50.8	42.2	33	25.6				18
19	59.3	60.4	57.3	54	51.5	47.8	42.3	33.1	25.8				19
20	55.3	56.4	53.3	51.6	48.3	44.8	41.1	33.1	26	20.6			20
22	47.4	48.9	47.2	45.5	42.7	39.7	37.7	33.4	26.3	20.8	15.9		22
24	40.3	41.8	42.5	40.5	38.1	35.8	33.6	32.2	26.5	21	16		24
26		36.9	38	36.4	34.3	32.1	31.2	29.8	26.5	21.2	16.2	13.5	26
28		32.5	33.5	32.8	30.9	29.9	28.6	27	25.2	21.3	16.4	13.6	28
30		28.8	29.9	29.7	28	27.8	26.1	24.6	23	21.4	16.4	13.7	30
32		25.8	26.8	27	26	25.5	23.9	23.2	22	20.6	16.4	13.8	32
34		23.2	24.1	24.3	24.8	23.4	22	21.6	20.5	19.1	16.3	13.8	34
36		20.9	21.8	22.1	22.9	21.6	21.1	20	19	17.8	16.1	13.8	36
38			19.9	20.9	20.9	20	19.7	18.6	17.9	16.9	15.8	13.8	38
40			18.2	19.2	19.2	18.6	18.4	17.6	16.7	16	14.9	13.6	40
45			14.8	15.8	15.7	16	15.6	15.2	14.2	13.5	12.5	12.2	45
50				13.2	13.2	13.5	13.3	13	12.1	11.5	10.6	10.3	50
55				11.2	11.2	11.5	11.3	11.2	10.5	9.9	9	8.7	55
60					9.6	9.9	9.7	9.5	8.9	8.5	7.7	7.4	60
65					8.4	8.6	8.3	8.2	7.7	7.3	6.6	6.3	65
70					7.3	7.5	7.3	7.1	6.6	6.3	5.6	5.4	70
75						6.6	6.4	6.2	5.8	5.4	4.8	4.6	75
80						5.8	5.5	5.5	5	4.7	4.1	3.9	80
85							4.8	4.7	4.3	4	3.4	3.3	85
90							4.2	4.1	3.7	3.4	2.9	2.8	90
95								3.6	3.2	2.9	2.4	2.3	95
100								3.1	2.7	2.4	1.9	1.8	100
105								2.7	2.3	2			105
110									1.9				110

t_250_00511_00_000

Lifting capacities Forces de levage

T



34 - 157 ft



85%

	34 ft	45 ft	57 ft	68 ft	79 ft	91 ft	102 ft	113 ft	125 ft	136 ft	148 ft	157 ft	
10	93.3	91.7	89.1	75.2	65.2	50.2							10
11	93.3	92.7	89.7	75.7	65.8	50.8							11
12	93.3	93.2	89.8	76.1	66.5	51.4							12
13	93.3	92.5	84.6	76.6	66.7	52	41						13
14	90.3	87.4	79.4	74.9	66.3	52.5	41.4						14
15	85.1	81.5	74.3	70.2	65.9	53	41.7	32.3					15
16	80.1	76.6	70.1	67.5	61.7	53.1	42	32.6					16
17	74.6	71.9	66.2	62	58.9	52.5	42.1	32.8					17
18	69.6	66	61.9	57.4	55.3	50.8	42.2	33	25.6				18
19	63.3	60.9	57.3	54	51.5	47.8	42.3	33.1	25.8				19
20	57.1	56.4	53.3	51.6	48.3	44.8	41.1	33.1	26	20.6			20
22	47.4	48.9	47.2	45.5	42.7	39.7	37.7	33.4	26.3	20.8	15.9		22
24	40.3	41.8	42.5	40.5	38.1	35.8	33.8	32.2	26.5	21	16		24
26		36.9	38	36.4	34.4	32.3	31.5	30.1	26.7	21.2	16.2	13.5	26
28		32.5	33.5	33	31.2	29.9	29	27.5	25.7	21.3	16.4	13.6	28
30		28.8	29.9	30	28.4	28.1	26.6	25.2	23.7	21.4	16.4	13.7	30
32		25.9	26.8	27	26.1	26	24.5	23.3	22.3	21.1	16.4	13.8	32
34		23.4	24.3	24.5	25	24	22.6	22.1	21.2	19.8	16.3	13.8	34
36		21.3	22.1	22.3	23.1	22.3	21.1	20.6	19.7	18.4	16.1	13.8	36
38			20.3	21.2	21.2	20.7	20.2	19.3	18.4	17.4	15.8	13.8	38
40			18.6	19.6	19.6	19.2	19.1	18	17.3	16.5	15.6	13.6	40
45			15.4	16.3	16.2	16.5	16.2	15.9	15	14.3	13.3	12.8	45
50				13.7	13.7	14	13.7	13.7	12.9	12.3	11.4	11	50
55				11.8	11.8	12	11.8	11.8	11.2	10.6	9.7	9.4	55
60					10.2	10.4	10.2	10.2	9.6	9.2	8.4	8.1	60
65					8.9	9.1	8.9	8.8	8.3	7.9	7.2	7	65
70					7.8	8.1	7.8	7.7	7.2	6.9	6.3	6.1	70
75						7.1	6.9	6.8	6.3	6	5.4	5.2	75
80						6.3	6.1	6	5.5	5.2	4.7	4.5	80
85							5.3	5.2	4.8	4.6	4	3.9	85
90							4.7	4.6	4.2	4	3.4	3.3	90
95								4	3.6	3.4	2.9	2.8	95
100								3.6	3.1	2.9	2.4	2.3	100
105								3.1	2.7	2.4	1.9	1.9	105
110									2.3	2			110
115									2				115

t_250_00211_00_000

Lifting capacities Forces de levage

T





34 - 157 ft
 360°
 9500 lbs
85%

	34 ft	45 ft	57 ft	68 ft	79 ft	91 ft	102 ft	113 ft	125 ft	136 ft	148 ft	157 ft	
10	93.3	91.7	89.1	75.2	65.2	50.2							10
11	93.3	92.7	89.7	75.7	65.8	50.8							11
12	92.1	91	89.8	76.1	66.5	51.4							12
13	87.6	86.8	84.6	76.6	66.7	52	41						13
14	81.9	81	78.1	72.7	66	52.5	41.4						14
15	76.4	76.4	72	67.8	63.1	53	41.7	32.3					15
16	71.5	72.5	69.6	64	60.1	53.1	42	32.6					16
17	66.6	67.6	63.8	58.8	56.5	51.8	42.1	32.8					17
18	62.1	62.4	58.7	56.2	52.4	48.3	41.9	33	25.6				18
19	57.8	57.7	54.3	52.6	48.8	45.3	41.4	33.1	25.8				19
20	53.5	53.4	50.5	48.9	45.7	42.4	39.9	33.1	26	20.6			20
22	44.8	46.2	45.5	43.1	40.4	37.8	35.4	32.8	26.3	20.8	15.9		22
24	38	39.8	40.3	38.4	35.9	33.5	32.4	30.8	26.5	21	16		24
26		34.9	35.8	34.2	32.1	30.9	29.5	27.8	25.6	21.2	16.2	13.5	26
28		30.7	31.7	30.7	28.8	28.5	26.7	25.2	23.6	21.2	16.4	13.6	28
30		27.1	28.2	27.7	26.9	26.1	24.3	23.6	22.4	20.9	16.4	13.7	30
32		24.1	25.1	25.2	25.2	23.8	22.7	21.8	20.7	19.2	16.4	13.8	32
34		21.6	22.6	22.9	23.1	21.8	21.4	20.1	19.3	17.9	16.3	13.8	34
36		19.4	20.4	21.4	21.4	20.1	19.8	18.8	18.1	17	15.8	13.8	36
38			18.5	19.6	19.6	19.2	18.4	17.9	16.8	15.9	14.8	13.8	38
40			16.9	17.9	17.9	18.1	17.1	16.6	15.6	14.8	13.7	13.2	40
45			13.8	14.7	14.7	15	14.6	14	13.1	12.4	11.4	11.2	45
50				12.3	12.2	12.5	12.3	12	11.2	10.5	9.6	9.4	50
55				10.4	10.4	10.7	10.4	10.3	9.6	9	8.1	7.9	55
60					8.9	9	8.9	8.7	8.2	7.7	6.9	6.6	60
65					7.7	7.8	7.6	7.5	7	6.6	5.8	5.6	65
70					6.7	6.9	6.6	6.5	6	5.6	4.9	4.7	70
75						6	5.7	5.6	5.2	4.8	4.2	4	75
80						5.2	5	4.9	4.4	4.1	3.5	3.3	80
85							4.3	4.2	3.8	3.5	2.9	2.7	85
90							3.7	3.6	3.2	3	2.3	2.2	90
95								3.1	2.7	2.4	1.8	1.8	95
100								2.7	2.2	2			100
105								2.3	1.8				105

t_250_00513_00_000

Lifting capacities Forces de levage

T

34 - 157 ft



85%

	34 ft	45 ft	57 ft	68 ft	79 ft	91 ft	102 ft	113 ft	125 ft	136 ft	148 ft	157 ft	
10	93.3	91.7	89.1	75.2	65.2	50.2							10
11	93.3	92.7	89.7	75.7	65.8	50.8							11
12	93.3	93.2	89.8	76.1	66.5	51.4							12
13	93.3	92.5	84.6	76.6	66.7	52	41						13
14	89.6	86.9	78.1	72.7	66	52.5	41.4						14
15	84.3	78.9	72	67.8	63.1	53	41.7	32.3					15
16	78.5	75	69.6	64	60.1	53.1	42	32.6					16
17	72.8	68.2	63.8	58.8	56.5	51.8	42.1	32.8					17
18	66.8	62.5	58.7	56.2	52.4	48.3	41.9	33	25.6				18
19	60	57.7	54.3	52.6	48.8	45.3	41.4	33.1	25.8				19
20	54	53.4	50.5	48.9	45.7	42.4	39.9	33.1	26	20.6			20
22	44.8	46.2	45.5	43.1	40.4	37.8	35.6	32.9	26.3	20.8	15.9		22
24	38	39.8	40.3	38.4	36.1	33.8	32.7	31.3	26.5	21	16		24
26		34.9	36	34.5	32.5	31	30	28.4	26	21.2	16.2	13.5	26
28		30.7	31.7	31.2	29.4	29	27.4	25.9	24.3	21.3	16.4	13.6	28
30		27.3	28.3	28.4	27.1	26.8	25.1	24.1	22.8	21.3	16.4	13.7	30
32		24.4	25.3	25.6	25.9	24.6	23.1	22.6	21.6	20.1	16.4	13.8	32
34		22	22.9	23.1	23.9	22.7	21.7	21	19.9	18.6	16.3	13.8	34
36		20	20.9	21.9	21.9	21	20.7	19.5	18.8	17.5	16.1	13.8	36
38			19.1	20.1	20.1	19.5	19.3	18.2	17.7	16.7	15.7	13.8	38
40			17.5	18.5	18.5	18.4	18	17.4	16.5	15.7	14.7	13.6	40
45			14.4	15.3	15.3	15.6	15.3	14.9	14	13.4	12.4	12	45
50				12.9	12.9	13.2	13	12.9	12	11.4	10.5	10.2	50
55				11.1	11	11.3	11.1	11	10.4	9.9	9	8.7	55
60					9.5	9.8	9.5	9.4	8.9	8.5	7.7	7.4	60
65					8.3	8.5	8.3	8.1	7.7	7.3	6.6	6.4	65
70					7.3	7.5	7.3	7.1	6.6	6.3	5.7	5.5	70
75						6.6	6.4	6.2	5.8	5.5	4.8	4.7	75
80						5.8	5.5	5.5	5.1	4.7	4.1	4	80
85							4.9	4.8	4.4	4.1	3.5	3.4	85
90							4.3	4.2	3.8	3.5	3	2.8	90
95								3.6	3.2	3	2.5	2.4	95
100								3.2	2.7	2.5	2	1.9	100
105								2.8	2.3	2.1			105
110									2				110

t_250_00213_00_000

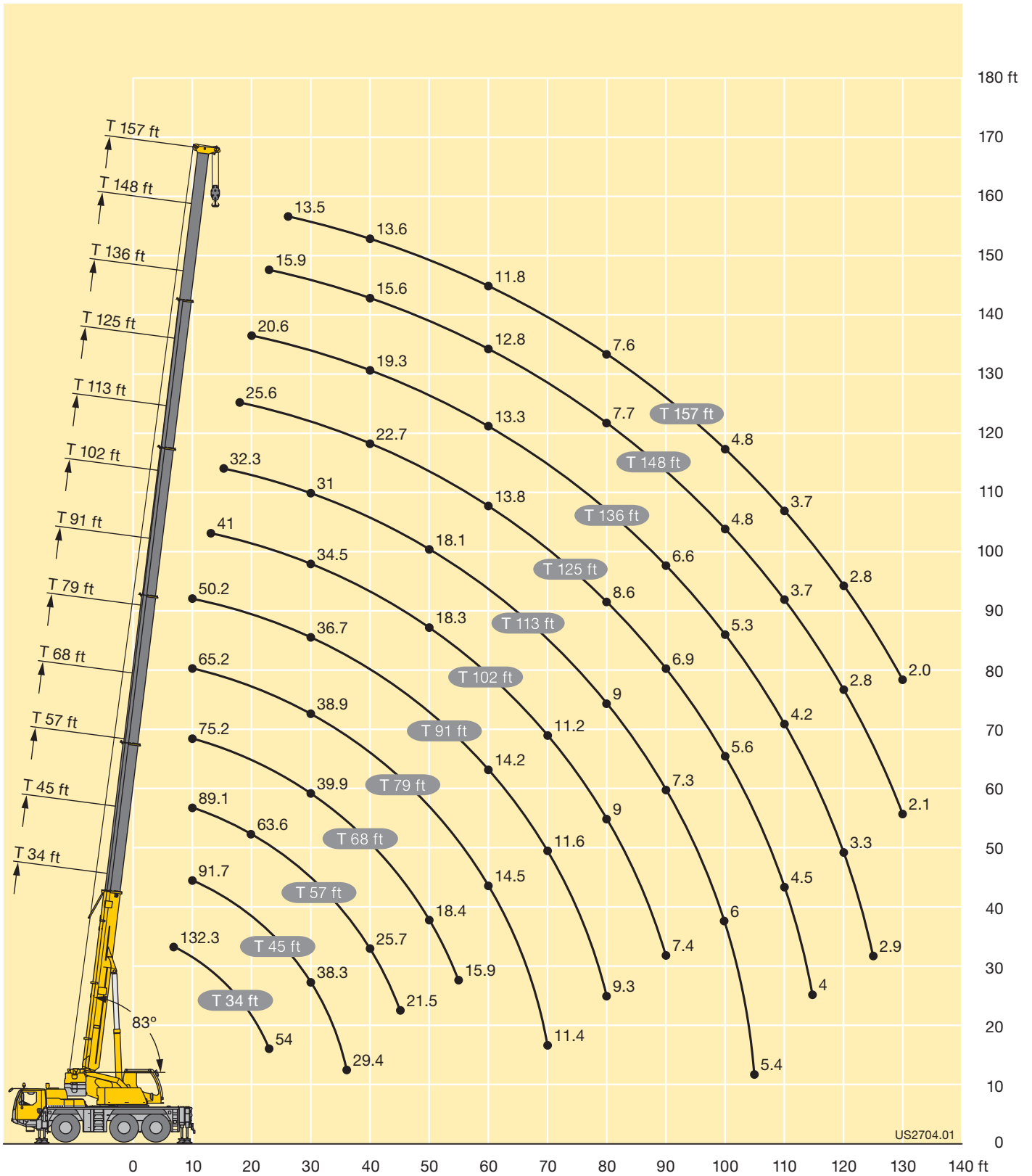
Lifting heights Hauteurs de levage

T



US2704.01

Lifting capacities Forces de levage

TK



ft	34 ft			113 ft			125 ft			136 ft			148 ft			157 ft			ft
	31 ft			31 ft			31 ft			31 ft			31 ft			31 ft			
	0°	20°	40°	0°	20°	40°	0°	20°	40°	0°	20°	40°	0°	20°	40°	0°	20°	40°	
10	17.5																		10
11	17.1																		11
12	16.7	14.8																	12
13	16.4	14.8																	13
14	16	14.8																	14
15	15.6	14.8																	15
16	15.2	14.8																	16
17	14.8	14.7																	17
18	14.5	14.6																	18
19	14.1	14.4	11.5	16.7															19
20	13.7	14.2	11.5	16.7															20
22	13	13.7	11.5	16.8			14												22
24	12.3	13.2	11.5	16.7			14			11.5									24
26	11.6	12.7	11.4	16.5			14			11.6									26
28	11	12.2	11.3	16.4			14			11.6									28
30	10.3	11.6	11.1	16.2	14.3		13.9			11.7									30
32	9.6	11.1	10.9	16	14.1		13.8	12.8		11.7									32
34	8.9	10.4	10.6	15.9	13.9		13.8	12.6		11.7									34
36	8.4	9.8	10.1	15.7	13.7	11.5	13.7	12.5		11.7	11.1		8.6						36
38	7.8	9.2	9.6	15.5	13.5	11.5	13.6	12.4		11.6	11		8.6	8.8		7.5			38
40	7.2	8.6	9.1	15.3	13.3	11.5	13.5	12.2	11	11.6	10.9		8.6	8.7		7.5			40
45	6.2	7.5	7.8	14.9	12.9	11.3	13.2	11.9	10.8	11.4	10.7	9.9	8.6	8.6		7.4	7.5		45
50	5.1	6.2	6.1	14.4	12.4	11	12.9	11.5	10.5	11.2	10.5	9.7	8.5	8.4	8.1	7.4	7.4	7.4	50
55	4.2	4.5		13.6	12	10.7	12.6	11.2	10.2	10.9	10.3	9.4	8.3	8.2	7.8	7.4	7.3	7.2	55
60				12.6	11.6	10.4	12	10.9	10	10.5	9.8	9.3	8.1	7.9	7.6	7.2	7.2	7.1	60
65				11.6	11.1	10.1	10.6	10.6	9.4	10	9.3	9	7.9	7.7	7.4	7	7	6.9	65
70				10.3	10.5	9.6	9.7	10.1	9.2	9.3	9	8.7	7.7	7.5	7.2	6.9	6.8	6.7	70
75				9.1	9.7	9.2	9.1	9	9	8.4	8.6	8.4	7.4	7.3	7	6.7	6.6	6.6	75
80				8.4	8.6	8.8	8.1	8.4	8.5	7.6	8	8.1	7.1	7	6.9	6.5	6.4	6.4	80
85				7.6	7.9	7.9	7.5	7.7	7.9	7.2	7.2	7.6	6.7	6.8	6.7	6.2	6.2	6.3	85
90				7.1	7.2	7.4	6.8	7	7.2	6.6	6.7	6.8	6	6.5	6.5	5.8	6	6.1	90
95				6.4	6.6	6.6	6.3	6.5	6.6	5.9	6.3	6.4	5.4	5.8	6.2	5.2	5.6	5.8	95
100				6	6.1	6.2	5.6	5.9	6.1	5.2	5.7	6	4.8	5.2	5.5	4.6	5	5.4	100
105				5.4	5.7	5.8	5	5.3	5.6	4.6	5.1	5.3	4.2	4.6	4.9	4.1	4.5	4.8	105
110				4.9	5.1		4.5	4.7	5	4.1	4.5	4.7	3.7	4.1	4.3	3.6	4	4.2	110
115				4.4	4.6		4	4.2	4.4	3.6	4	4.2	3.2	3.6	3.8	3.1	3.5	3.8	115
120				4	4.2		3.6	3.8		3.2	3.5	3.7	2.8	3.1	3.3	2.7	3	3.3	120
125				3.6	3.7		3.2	3.4		2.8	3.1		2.4	2.7	2.8	2.3	2.6	2.8	125
130				3.3			2.8	3		2.5	2.7		2	2.3	2.4	2	2.2	2.4	130
135				3			2.5	2.6		2.1	2.4		1.7	1.9		1.6	1.9	2	135
140							2.2			1.8	2			1.6			1.6	1.7	140
145							1.9			1.6	1.7								145

t_250_11001_00_000 / 12001_00_000 / 13001_00_000

Lifting capacities Forces de levage

TK



ft	34 ft			113 ft			125 ft			136 ft			148 ft			157 ft			ft
	52 ft			52 ft			52 ft			52 ft			52 ft			52 ft			
	0°	20°	40°	0°	20°	40°	0°	20°	40°	0°	20°	40°	0°	20°	40°	0°	20°	40°	
10	9																		10
11	9																		11
12	9																		12
13	8.9																		13
14	8.9																		14
15	8.8																		15
16	8.7																		16
17	8.6																		17
18	8.4																		18
19	8.3																		19
20	8.2																		20
22	8	8.7		8.6															22
24	7.7	8.4		8.6			7.7												24
26	7.5	8.2		8.5			7.6												26
28	7.2	8		8.5			7.6			6.7									28
30	7	7.7		8.4			7.5			6.7			5.8						30
32	6.9	7.5		8.3			7.5			6.7			5.8			5.1			32
34	6.7	7.3		8.2			7.4			6.6			5.7			5.1			34
36	6.5	7.1	5.3	8.2			7.4			6.6			5.7			5.1			36
38	6.3	6.9	5.3	8.1			7.3			6.6			5.7			5.1			38
40	6.1	6.7	5.3	8	6.9		7.3			6.5			5.7			5.1			40
45	5.7	6.3	5.1	7.8	6.7		7.2	6.3		6.5			5.7			5			45
50	5.3	6	5.1	7.6	6.5		7	6.2		6.4	5.8		5.6	5.3		4.9			50
55	4.8	5.7	5	7.4	6.3	5.3	6.9	6		6.3	5.7		5.6	5.2		4.9	4.8		55
60	4.2	5.3	4.8	7.2	6.1	5.3	6.7	5.9	5.1	6.2	5.6	5	5.5	5.1		4.8	4.8		60
65	3.7	4.7	4.7	7	5.9	5.2	6.6	5.7	5.1	6.1	5.5	4.9	5.4	5.1	4.7	4.8	4.8		65
70	3.3	4	4.4	6.8	5.8	5.1	6.4	5.6	5	5.9	5.4	4.9	5.4	5	4.7	4.8	4.7	4.5	70
75	2.9	3.3		6.6	5.6	5	6.2	5.5	4.9	5.8	5.2	4.8	5.3	4.9	4.6	4.7	4.7	4.5	75
80				6.3	5.5	4.9	6.1	5.4	4.9	5.7	5.2	4.7	5.2	4.9	4.6	4.7	4.6	4.5	80
85				6.1	5.4	4.9	5.9	5.2	4.8	5.6	5.1	4.7	5.2	4.8	4.6	4.7	4.6	4.4	85
90				5.9	5.3	4.8	5.8	5.1	4.7	5.5	5	4.7	5.1	4.8	4.5	4.7	4.5	4.4	90
95				5.7	5.2	4.8	5.5	5.1	4.7	5.3	4.9	4.6	5	4.7	4.5	4.6	4.5	4.4	95
100				5.3	5.1	4.7	5.3	5	4.7	5.1	4.8	4.6	4.8	4.6	4.5	4.4	4.4	4.3	100
105				5	4.9	4.7	5	4.9	4.7	4.8	4.8	4.6	4.3	4.6	4.4	4.1	4.3	4.2	105
110				4.7	4.8	4.7	4.7	4.7	4.7	4.4	4.6	4.6	3.8	4.4	4.3	3.6	4.2	4.2	110
115				4.5	4.6	4.7	4.3	4.4	4.7	3.9	4.4	4.4	3.4	4	4.2	3.2	3.8	4.1	115
120				4.3	4.2	4.4	3.9	4.2	4.2	3.5	4	4.2	3	3.6	4	2.8	3.4	3.8	120
125				3.9	4.1	4.1	3.5	3.9	4.1	3.1	3.6	3.9	2.6	3.2	3.6	2.4	3	3.4	125
130				3.5	3.8		3.1	3.5	3.7	2.7	3.2	3.5	2.3	2.8	3.1	2.1	2.6	3	130
135				3.2	3.4		2.7	3.1	3.3	2.4	2.8	3	1.9	2.4	2.7	1.8	2.3	2.6	135
140				2.9	3.1		2.4	2.7		2.1	2.4	2.7	1.6	2	2.3		2	2.3	140
145				2.6	2.8		2.2	2.4		1.8	2.1	2.3		1.7	2		1.7	1.9	145
150				2.3	2.5		1.9	2.1			1.8				1.6			1.6	150
155				2.1			1.7	1.8			1.6								155
160								1.6											160

t_250_21001_00_000 / 22001_00_000 / 23001_00_000

Lifting capacities Forces de levage

TK



ft	34 ft			113 ft			125 ft			136 ft			148 ft			157 ft			ft
	31 ft			31 ft			31 ft			31 ft			31 ft			31 ft			
	0°	20°	40°	0°	20°	40°	0°	20°	40°	0°	20°	40°	0°	20°	40°	0°	20°	40°	
10	17.5																		10
11	17.1																		11
12	16.7	14.8																	12
13	16.4	14.8																	13
14	16	14.8																	14
15	15.6	14.8																	15
16	15.2	14.8																	16
17	14.8	14.7																	17
18	14.5	14.6																	18
19	14.1	14.4	11.5	16.7															19
20	13.7	14.2	11.5	16.7															20
22	13	13.7	11.5	16.8			14												22
24	12.3	13.2	11.5	16.7			14			11.5									24
26	11.6	12.7	11.4	16.5			14			11.6									26
28	11	12.2	11.3	16.4			14			11.6									28
30	10.3	11.6	11.1	16.2	14.3		13.9			11.7									30
32	9.6	11.1	10.9	16	14.1		13.8	12.8		11.7									32
34	8.9	10.4	10.6	15.9	13.9		13.8	12.6		11.7									34
36	8.4	9.8	10.1	15.7	13.7	11.5	13.7	12.5		11.7	11.1		8.6						36
38	7.8	9.2	9.6	15.1	13.5	11.5	13.6	12.4		11.6	11		8.6	8.8		7.5			38
40	7.2	8.6	9.1	14.6	13.3	11.5	13.5	12.2	11	11.6	10.9		8.6	8.7		7.5			40
45	6.2	7.5	7.8	12.9	12.8	11.3	12.3	11.9	10.8	11.2	10.7	9.9	8.6	8.6		7.4	7.5		45
50	5.1	6.2	6.1	11.4	11.8	11	10.9	11.1	10.5	10.1	10.4	9.7	8.5	8.4	8.1	7.4	7.4	7.4	50
55	4.2	4.5		10.2	10.7	10.4	9.6	10	10.1	9.1	9.2	9.4	8.1	8.2	7.8	7.4	7.3	7.2	55
60				9.3	9.3	9.6	8.5	8.6	9.3	7.9	8.2	8.7	7.2	7.9	7.6	6.8	7.2	7.1	60
65				8.1	8.2	8.6	7.4	8	8.1	6.8	7.6	7.6	6.1	6.9	7.4	5.9	6.7	6.9	65
70				7.1	7.6	7.5	6.5	7.1	7.4	5.9	6.6	7.2	5.2	6	6.6	5	5.8	6.4	70
75				6.3	6.8	7.1	5.6	6.2	6.8	5.1	5.8	6.3	4.4	5.1	5.6	4.3	4.9	5.5	75
80				5.5	6	6.4	4.9	5.4	5.9	4.4	5	5.5	3.8	4.4	4.8	3.6	4.2	4.7	80
85				4.8	5.3	5.6	4.3	4.7	5.2	3.7	4.4	4.7	3.2	3.7	4.1	3	3.6	4	85
90				4.2	4.6	4.9	3.7	4.1	4.5	3.2	3.8	4.1	2.6	3.1	3.5	2.5	3	3.4	90
95				3.7	4	4.3	3.2	3.6	3.9	2.7	3.2	3.5	2.1	2.6	2.9	2	2.5	2.8	95
100				3.2	3.4	3.7	2.7	3.1	3.4	2.2	2.7	3	1.7	2.1	2.4		2	2.3	100
105				2.7	3	3.2	2.3	2.6	2.9	1.8	2.3	2.5		1.7	2		1.6	1.9	105
110				2.3	2.5		1.9	2.2	2.4		1.9	2.1							110
115				2	2.2			1.8	2			1.7							115
120				1.6	1.8														120

t_250_11011_00_000 / 12011_00_000 / 13011_00_000

Lifting capacities Forces de levage

TK



ft	34 ft			113 ft			125 ft			136 ft			148 ft			157 ft			ft
	52 ft			52 ft			52 ft			52 ft			52 ft			52 ft			
	0°	20°	40°	0°	20°	40°	0°	20°	40°	0°	20°	40°	0°	20°	40°	0°	20°	40°	
10	9																		10
11	9																		11
12	9																		12
13	8.9																		13
14	8.9																		14
15	8.8																		15
16	8.7																		16
17	8.6																		17
18	8.4																		18
19	8.3																		19
20	8.2																		20
22	8	8.7		8.6															22
24	7.7	8.4		8.6			7.7												24
26	7.5	8.2		8.5			7.6												26
28	7.2	8		8.5			7.6			6.7									28
30	7	7.7		8.4			7.5			6.7			5.8						30
32	6.9	7.5		8.3			7.5			6.7			5.8			5.1			32
34	6.7	7.3		8.2			7.4			6.6			5.7			5.1			34
36	6.5	7.1	5.3	8.2			7.4			6.6			5.7			5.1			36
38	6.3	6.9	5.3	8.1			7.3			6.6			5.7			5.1			38
40	6.1	6.7	5.3	8	6.9		7.3			6.5			5.7			5.1			40
45	5.7	6.3	5.1	7.8	6.7		7.2	6.3		6.5			5.7			5			45
50	5.3	6	5.1	7.6	6.5		7	6.2		6.4	5.8		5.6	5.3		4.9			50
55	4.8	5.7	5	7.4	6.3	5.3	6.9	6		6.3	5.7		5.6	5.2		4.9	4.8		55
60	4.2	5.3	4.8	7.1	6.1	5.3	6.7	5.9	5.1	6.2	5.6	5	5.5	5.1		4.8	4.8		60
65	3.7	4.7	4.7	6.7	5.9	5.2	6.3	5.7	5.1	5.9	5.5	4.9	5.4	5.1	4.7	4.8	4.8		65
70	3.3	4	4.4	6.3	5.8	5.1	6	5.6	5	5.6	5.4	4.9	5.1	5	4.7	4.8	4.7	4.5	70
75	2.9	3.3		6	5.5	5	5.8	5.4	4.9	5.2	5.2	4.8	4.5	4.9	4.6	4.3	4.7	4.5	75
80				5.7	5.3	4.9	5.1	5.2	4.9	4.5	5	4.7	3.8	4.7	4.6	3.7	4.5	4.5	80
85				5.1	5.1	4.8	4.5	5	4.8	3.9	4.7	4.7	3.2	4.2	4.6	3.1	4	4.4	85
90				4.5	4.9	4.8	3.9	4.7	4.7	3.4	4.2	4.6	2.7	3.6	4.3	2.5	3.4	4.2	90
95				4	4.6	4.7	3.4	4.1	4.5	2.9	3.7	4.3	2.2	3.1	3.8	2.1	2.9	3.6	95
100				3.5	4.1	4.4	2.9	3.6	4.1	2.4	3.2	3.7	1.8	2.6	3.2	1.6	2.4	3.1	100
105				3	3.6	4	2.5	3.1	3.6	2	2.7	3.2		2.1	2.7		2	2.6	105
110				2.6	3.1	3.4	2.2	2.7	3.1	1.7	2.3	2.8		1.7	2.3		1.6	2.2	110
115				2.3	2.7	3	1.8	2.3	2.7		1.9	2.3			1.8			1.7	115
120				1.9	2.3	2.6		2	2.3		1.6	1.9							120
125				1.6	2	2.2		1.6	1.9			1.6							125
130					1.7				1.6										130

t_250_21011_00_000 / 22011_00_000 / 23011_00_000

Lifting heights Hauteurs de levage

TK

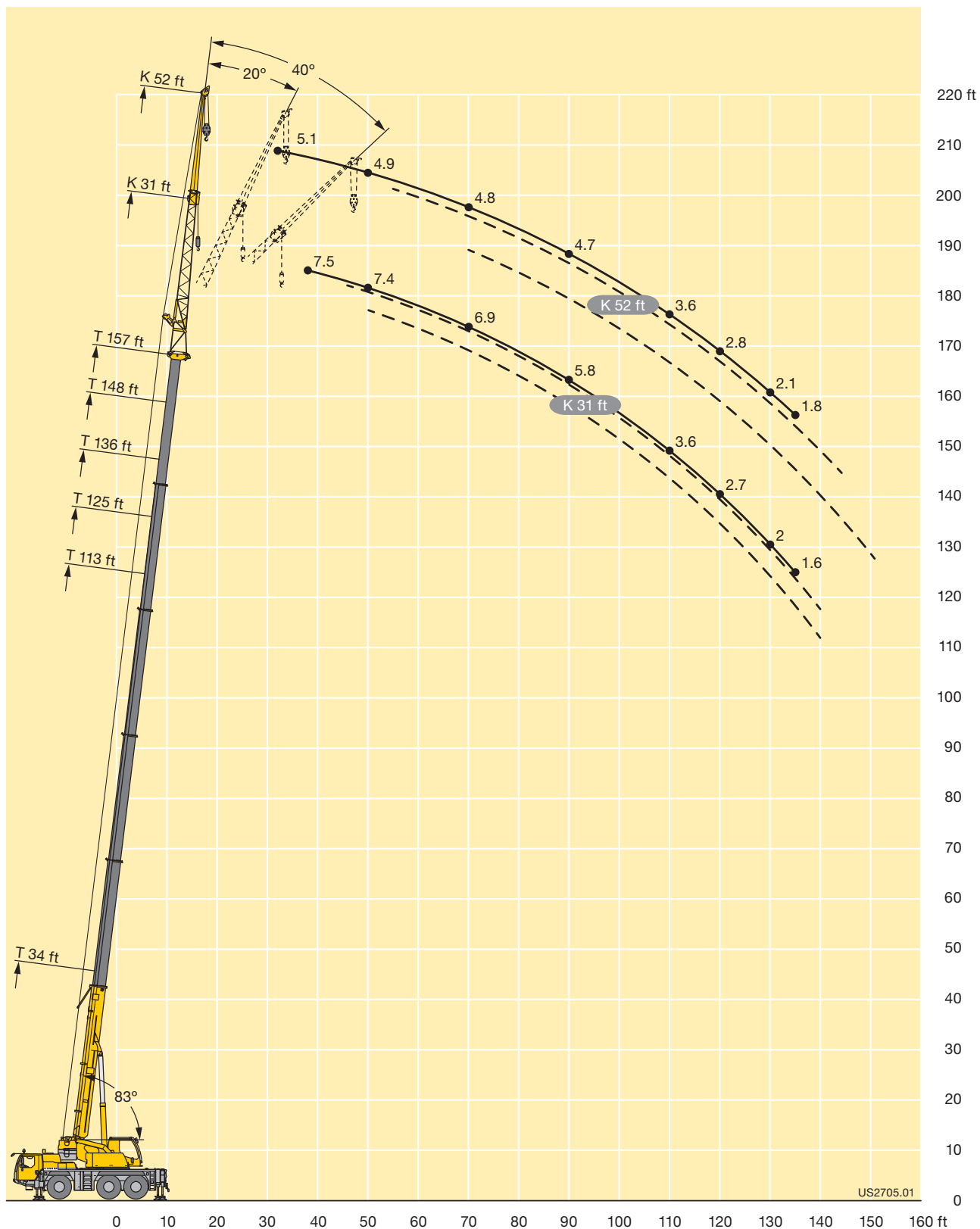

Lifting capacities Forces de levage

TK

	34 ft	45 ft	57 ft	68 ft	79 ft	91 ft	102 ft	113 ft	125 ft	136 ft	148 ft	157 ft	
	8 ft												
10	39	39	39	39									10
11	39	39	39	39									11
12	39	39	39	39									12
13	39	39	39	39	39								13
14	39	39	39	39	39								14
15	39	39	39	39	39								15
16	39	39	39	39	39	39							16
17	39	39	39	39	39	39							17
18	39	39	39	39	39	38.9							18
19	39	39	39	39	39	38.7	28.1						19
20	38.6	39	39	39	39	38.4	36						20
22	35.9	39	39	39	39	37.5	35.8						22
24	32.9	39	39	39	39	36.3	35.2	28.5					24
26	29.8	39	39	39	39	35	34.3	28.4	22.3				26
28	27.2	37.5	39	39	39	33.8	33.4	28.1	21.9				28
30	24.8	35.2	38.5	38.2	36.6	32.8	32.5	27.5	21.6	17.8			30
32	22.8	32.9	36.2	35.9	33.9	31.7	31.3	26.8	21.1	17.6	14.3		32
34		30.5	33.1	32.8	31.3	30.4	29.3	26	20.7	17.4	14.2		34
36		28.3	30.3	30	29	28.9	27.2	25.1	20.1	17.2	14	12.2	36
38		26.5	27.8	27.5	27.6	27	25.5	24.1	19.5	16.9	13.9	12.1	38
40		24.7	25.7	25.4	26.1	25.2	24.2	22.8	19	16.6	13.7	12	40
45		20	21.4	22.1	21.8	21.3	20.7	19.5	17.9	15.7	13.2	11.7	45
50			18.8	18.8	18.5	18.1	17.7	17.1	16.8	14.9	12.7	11.3	50
55			16.3	16.3	15.9	15.5	15.6	15.6	14.7	14.1	12.2	10.9	55
60				14.2	13.8	14.1	13.9	13.6	13.3	12.9	11.7	10.4	60
65				12.5	12.5	12.6	12.1	12.3	12.1	11.4	11	9.7	65
70					11.5	11.1	11.2	10.9	10.8	10.6	9.9	9.2	70
75					10.2	9.9	10.1	9.7	9.6	9.5	8.8	8.6	75
80						9.1	9	8.9	8.7	8.4	7.8	7.7	80
85						8.4	8.1	8.1	7.8	7.5	6.9	6.8	85
90						7.7	7.4	7.3	6.9	6.6	6.1	6.1	90
95							6.7	6.5	6.2	5.9	5.4	5.4	95
100							6	5.9	5.5	5.2	4.7	4.7	100
105								5.3	4.9	4.6	4.1	4.1	105
110								4.8	4.4	4.1	3.6	3.6	110
115									3.9	3.6	3.1	3.1	115
120									3.5	3.2	2.7	2.7	120
125									3.1	2.8	2.3	2.3	125
130										2.4	1.9	1.9	130
135										2.1	1.6	1.6	135

t_250_30001_00_000

Lifting capacities Forces de levage

TK

	34 ft	45 ft	57 ft	68 ft	79 ft	91 ft	102 ft	113 ft	125 ft	136 ft	148 ft	157 ft	
	8 ft												
10	39	39	39	39									10
11	39	39	39	39									11
12	39	39	39	39									12
13	39	39	39	39	39								13
14	39	39	39	39	39								14
15	39	39	39	39	39								15
16	39	39	39	39	39	39							16
17	39	39	39	39	39	39							17
18	39	39	39	39	39	38.9							18
19	39	39	39	39	39	38.7	28.1						19
20	38.6	39	39	39	39	38.4	36						20
22	35.9	39	39	38.9	38.9	37.5	35.8						22
24	32.9	39	38.7	38.5	35.8	35	33.1	28.5					24
26	29.8	37.5	36.8	34.6	33.5	31.8	29.9	27.5	22.3				26
28	27.2	33.4	33.2	31.2	30.6	28.7	27	25.2	21.9				28
30	24.8	29.7	29.9	29.2	27.9	26.2	24.6	22.9	21.6	17.8			30
32	22.8	26.7	26.9	27.1	25.5	23.9	22.4	21.7	20.7	17.6	14.3		32
34		23.9	24.8	24.8	23.4	21.9	21.2	20.6	19.1	17.4	14.2		34
36		21.6	22.7	22.7	21.5	20.2	19.9	19	17.8	16.9	14	12.2	36
38		20.1	20.7	20.7	19.9	19.2	18.6	17.6	17.1	16.2	13.9	12.1	38
40		18.4	19	19	18.5	18.3	17.3	16.8	16.1	15	13.7	12	40
45		15	15.5	15.5	15.8	15.6	15.2	14.5	14	13.3	12.3	11.6	45
50			12.9	13.5	13.5	13.6	13.2	12.8	12	11.3	10.4	10.1	50
55			10.9	11.5	11.4	11.6	11.4	11	10.4	9.7	8.8	8.6	55
60				9.9	9.8	10	9.8	9.6	9	8.3	7.5	7.4	60
65				8.6	8.5	8.7	8.5	8.3	7.8	7.2	6.4	6.3	65
70					7.4	7.6	7.4	7.2	6.8	6.2	5.5	5.3	70
75					6.5	6.7	6.4	6.3	5.9	5.4	4.6	4.5	75
80						5.8	5.6	5.4	5.1	4.6	3.9	3.8	80
85						5.1	4.8	4.7	4.3	4	3.3	3.2	85
90						4.5	4.2	4.1	3.7	3.4	2.7	2.6	90
95							3.7	3.5	3.2	2.8	2.2	2.1	95
100							3.2	3	2.7	2.3	1.7	1.6	100
105								2.6	2.2	1.9			105
110								2.2	1.8				110

t_250_30011_00_000

Lifting heights Hauteurs de levage

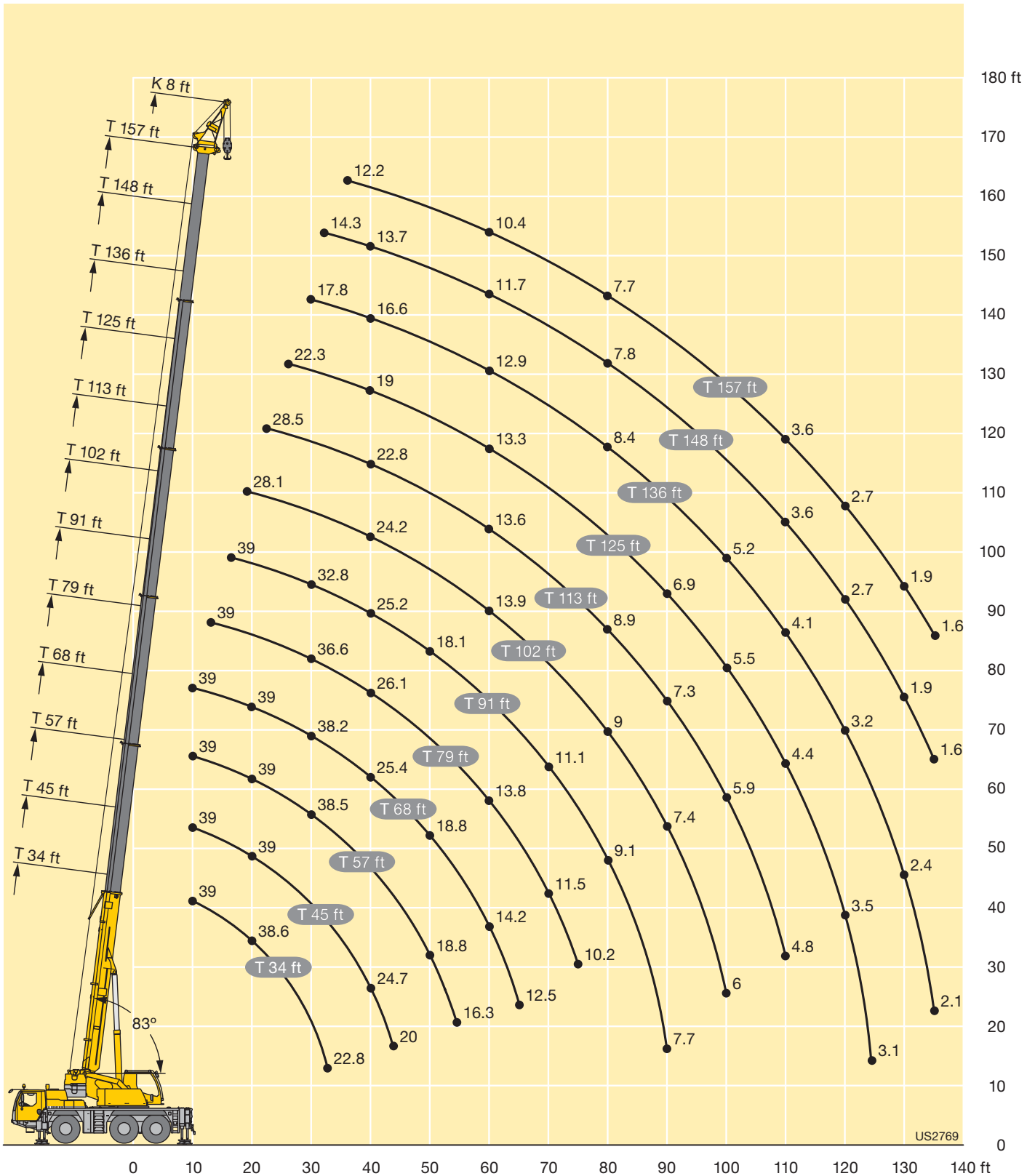

US2769

Equipment Equipment

Crane carrier

Frame	Liebherr designed and manufactured, box-type, torsion resistant design of high-tensile fine grained structural steel.
Outriggers	4-point supporting system, hydraulically telescopic into horizontal and vertical direction. Operation with remote control, automatic support leveling, electronic inclination display.
Engine	6-cylinder Diesel engine, make Liebherr, watercooled, 270 kW (367 h.p.), max. torque 1254 lbs-ft. Exhaust emissions acc. to 97/68/EG and EPA/CARB. Electronic engine management. Fuel tank: 92 gallons. Adblue reservoir: 10.5 gallons.
Transmission	ZF 12-speed gear box with automatic control system AS-TRONIC. Two-stage transfer case with lockable transfer differential.
Axles	All axles steered, axle 2 and 3 driven with lockable differential gears.
Suspension	All axles with hydropneumatic suspension and hydraulic locking facility.
Tyres	6 tyres. Tyre size: 445/95 R 25 (16.00 R 25).
Steering	2-circuit system with hydraulic servo steering. Active speed depending rear axle steering, special steering programs for various driving situations.
Brakes	Service brake: all wheel servo air brake, all axles are equipped with disc brakes, dual circuit. Hand brake: Spring loaded, acting on all wheels of axles 1, 2 and 3. Sustained action brake: Exhaust retarder with additional Liebherr braking system. Anti lock device.
Driver's cab	Spacious corrosion resistant with comfort furnishings, mounted on rubber shock absorbers, safety glazing.
Electrical system	Modern data bus technique, 24 Volt DC, 2 batteries of 170 Ah each.

Crane superstructure

Frame	Liebherr-made, torsion-resistant, welded construction of high-tensile structural steel, linked to carrier by a single-row ball bearing slewing ring, for continuous rotation.
Crane drive	Diesel-hydraulic with 1 axial variable displacement pump with automatic capacity control, 1 double gear pump, driven by the carrier Diesel engine, open regulated oil circuits with electrically controlled "load sensing", operation of 4 movements simultaneously.
Crane control	Electrical control of drives by self-centering joysticks, armrest-integrated control elements, Liebherr system bus (LSB).
Hoist gear	Axial piston fixed displacement motor, hoist drum with integrated planetary gear and spring-loaded static brake, actuation by open regulated oil circuit.
Luffing gear	1 differential ram with pilot operated brake valve.
Slewing gear	Axial piston fixed displacement motor, planetary gear, spring-loaded static brake. Slewing gear invertible from released to locked as a standard feature.
Crane cab	Large screen area, compound glass, comfort furnishing, cabin tiltable 20° to rear.
Safety devices	LICCON2 safe load indicator, hoist limit switch, safety valves against pipe and hose rupture, test system for servicing.
Telescopic boom	1 base section and 5 telescopic sections. All telescopic sections extendable hydraulically and independently from one another. Rapid-cycle telescoping system TELEMATIK. Boom length: 34 ft – 157 ft.
Counterweight	12100 lbs
Electric system	Control of the electrical and electronical components by modern data bus technique.

Additional equipment

Folding jib K	Single folding jib, 31 ft long, installation at 0°, 20° or 40°. Double folding jib, 31 ft – 52 ft long, installation at 0°, 20° or 40°.
Erection jib K	8 ft with steel cable pulleys.
2nd hoist gear	For two-hook operation or for operation with swing-away jib if the hoist rope shall remain reeved.
Tyres	6 tyres. Tyre size: 525/80 R 25 (20.5 R 25).
Drive 6 x 6	Axle 1 additionally driven.
Additional counterweight	16100 lbs for a total counterweight of 28200 lbs.

Other items of equipment available on request.

Equipment Equipment

Châssis porteur

Châssis	Fabrication Liebherr, construction en caisson indéformable, en acier à haute résistance à grains fins.
Stabilisateurs	Dispositif de calage horizontal et vertical en 4 points, entièrement déployable hydrauliquement. Utilisation avec commande à distance, mise à niveau automatique du calage, inclinomètre électronique.
Moteur	Diesel, 6 cylindres, marque Liebherr, refroidi par eau, puissance 270 kW (367 ch), couple max. 1254 lbs-ft. Emissions des gaz d'échappement conformes aux directives 97/68/EG et EPA/CARB. Gestion électronique. Réservoir à carburant: 92 gallons. Reservoir Adblue: 10.5 gallons.
Boîte de vitesse	Boîte de vitesses ZF à 12 rapports, mécanisme automatisé à commande AS-TRONIC. Boîte de transfert à 2 étages avec blocage de différentiel.
Essieux	Tous les essieux sont directeurs, les essieux 2 et 3 sont entraînés par des engrenages différentiels blocables.
Suspension	Tous les essieux sont suspendus hydropneumatiquement et blocable hydrauliquement.
Pneumatiques	6 roues. Taille: 445/95 R 25 (16.00 R 25).
Direction	2 circuits avec direction assistée hydraulique. Direction active des essieux arrière et dépendante de la vitesse, programmes de direction spéciaux pour les différents modes de déplacement.
Freins	Freins de service: servofrein à air comprimé, tous les essieux sont munis de freins à disque, à 2 circuits. Frein à main: par cylindres à ressorts, agissant sur les roues des essieux 1, 2 et 3. Frein à régime continu: Ralentisseur sur échappement avec système de freinage additionnel Liebherr. Dispositif anti enrayeur.
Cabine	Spacieuse cabine, traitement anticorrosion, équipement «grand confort», suspension par silentbloks, vitrage de sécurité.
Installation électrique	Technique moderne de transmission de données par BUS de données, courant continu 24 Volts, 2 batteries de 170 Ah chacune.

Partie tournante

Châssis	Fabrication Liebherr, construction mécanosoudée en tôle d'acier à haute résistance à grains fins. La couronne d'orientation à 1 rangée de billes, permettant une rotation illimitée, sert d'élément de liaison vers le châssis de la grue.
----------------	--

Entraînement	Diesel hydraulique avec 1 pompe double à débit variable et régulation de puissance automatique, 1 pompe à engrenages double, entraînés par le moteur Diesel du porteur, circuits hydrauliques ouverts avec «load sensing», régulé électriquement. 4 mouvements simultanés praticables.
Commande	Commande électrique des mécanismes par leviers de manoeuvre à centrage automatique, commandes de grue „grand confort“ intégrées aux accoudoirs du siège, Liebherr système bus.
Treuil	Moteur hydraulique à cylindrée constante, treuil à réducteur planétaire incorporé et frein d'arrêt à ressort, en circuit hydraulique ouvert ou fermé et régulé.
Relevage de flèche	1 vérin différentiel à soupape pilotage de freinage.
Orientation	Moteur à cylindrée constante à pistons axiaux, engrenage planétaire, frein d'arrêt commandé par ressort. Orientation de série commutable en circuit hydraulique ouvert ou fermé (freinage automatique ou au pied).
Cabine de grue	Large champ de vision, vitrage de sécurité, équipement pour un confort idéal, cabine inclinable de 20° vers l'arrière.
Sécurités	Contrôleur de charge LICCON2, fin de course crochet haut, clapets de sécurité en cas de ruptures de flexibles. Système de test pour faciliter l'entretien.
Flèche télescopique	1 élément de base et 5 éléments télescopiques. Chaque élément télescopable indépendamment de l'autre. Système de télescopage TELEMATIK séquentiel rapide. Longueur de flèche: 34 ft – 157 ft.
Contrepoids	12100 lbs
Circuit électrique	Composants électriques et électroniques reliés entre eux par bus de données moderne.

Équipement supplémentaire

Fléchette pliante K	Fléchette pliante simple, longueur 31 ft, montable à 0°, 20° ou 40°. Fléchette pliante double, longueur 31 ft – 52 ft, montable à 0°, 20° ou 40°.
Fléchette de montage K	8 ft avec poulies de câble en acier.
2ème mécanisme de levage	Pour l'utilisation du deuxième crochet, ou bien pour une utilisation avec fléchette pliante lorsque le câble de levage principal rest mouflé.
Pneumatiques	6 roues. Taille: 525/80 R 25 (20.5 R 25).
Entraînement 6 x 6	Essieu 1 est entraîné additionnellement.
Contrepoids supplémentaire	16100 lbs pour un contrepoids total de 28200 lbs.

Autres équipements supplémentaires sur demande.

Description of symbols Explication des symboles

General symbols Symboles généraux

	Outriggers Calage		Driving speed – Onroad gear Vitesse de translation – Vitesse de route
	Axle Essieu		Driving speed – Crawl speed Vitesse de translation – Marche lente
	Radius Portée		Transmission Boîte de vitesse
	Boom length Longueur de la flèche		Gear Vitesse
	Boom position Position de la flèche		Hookblock / Capacity Moufle à crochet / Capacité de charge
	Counterweight Contrepoids		Hoist gear Treuil de levage
	Tyres Pneumatiques		Crane carrier Châssis porteur
	Slewing gear / Working area Mécanisme d'orientation / Plage de travail		Crane superstructure Partie tournante de la grue
	Standard Norme		Gradability Aptitude à gravir les pentes
	Driving speed Vitesse de translation		

Crane specific symbols Symboles spécifiques à la grue

	Telescopic boom Flèche télescopique		Erection jib Fléchette de montage
	Swing away jib Fléchette pliante		

Remarks referring to load charts

1. The lifting capacities do not exceed 85 % of the tipping load according to ASME B 30.5.
The crane's structural steelwork is in accordance with EN 13000 and ASME B 30.5.
2. For the calculation of the load charts at least a wind speed of 30 ft/s (9 m/s, 20 mph) and regarding the load a sail area of 1 m² per ton load and a wind resistance coefficient of 1.2 on the load have been taken into account. For lifting of loads with large sail areas and/or high wind resistance coefficients the maximum wind speed as stated in the load charts has to be reduced.
3. Lifting capacities are given in kips.
4. The weight of the hook blocks and hooks must be deducted from the lifting capacities.
5. Working radii are measured from the slewing centreline.
6. The lifting capacities given for the telescopic boom only apply if the folding jib is taken off.
7. Lifting capacities above 93.3 kips only with additional pulley block.
8. The data of this brochure serves only for general information. All information is provided without warranty. Instructions for the correct commissioning of the crane please take from the operation manual and the load chart book.

Remarques relatives aux tableaux des charges

1. La capacité de charge ne doit pas dépasser 85 % de la charge de basculement conformément à ASME B 30.5.
La structure métallique de la grue est conforme à EN 13000 et ASME B 30.5.
2. Une vitesse de vent de 30 ft/s (9 m/s, 20 mph) minimum, une surface de prise au vent de 1 m² par tonne ainsi qu'un coefficient de résistance au vent de la charge 1,2 sont pris en compte pour le calcul des tableaux de charge. Lorsque des charges ayant une surface de prise au vent et/ou un coefficient de résistance au vent plus élevé(e)s sont levées, la vitesse de vent maximale indiquée dans les tableaux de charge doit être réduite.
3. Les forces de levage sont données en kips.
4. Les poids des moufles et crochets doit être soustrait des charges indiquées.
5. Les portées sont calculées à partir de l'axe de rotation.
6. Les forces indiquées pour la flèche télescopique s'entendent fléchette dépliée.
7. Les charges supérieures à 93.3 kips seulement avec moufle additionnel.
8. Les données de cette brochure sont données à titre informatif. Ces renseignements sont sans garantie. Les consignes relatives à la bonne mise en service de la grue sont disponibles dans le manuel d'utilisation et le manuel de tableaux de charge.

Subject to modification / Sous réserve de modifications

Printed in Germany (3)

TD 250.00.US07.2013

Liebherr-Werk Ehingen GmbH

Postfach 1361, 89582 Ehingen, Germany

☎ +49 73 91 5 02 0, Fax +49 73 91 5 02 33 99

www.liebherr.com, E mail: info.lwe@liebherr.com

www.facebook.com/LiebherrConstruction