



# GR-800XL-4

80 Ton (72.6 Metric Ton) Capacity

Form NO. GR-800-4-00101/US-03

## HYDRAULIC ROUGH TERRAIN CRANE

### DIMENSIONS

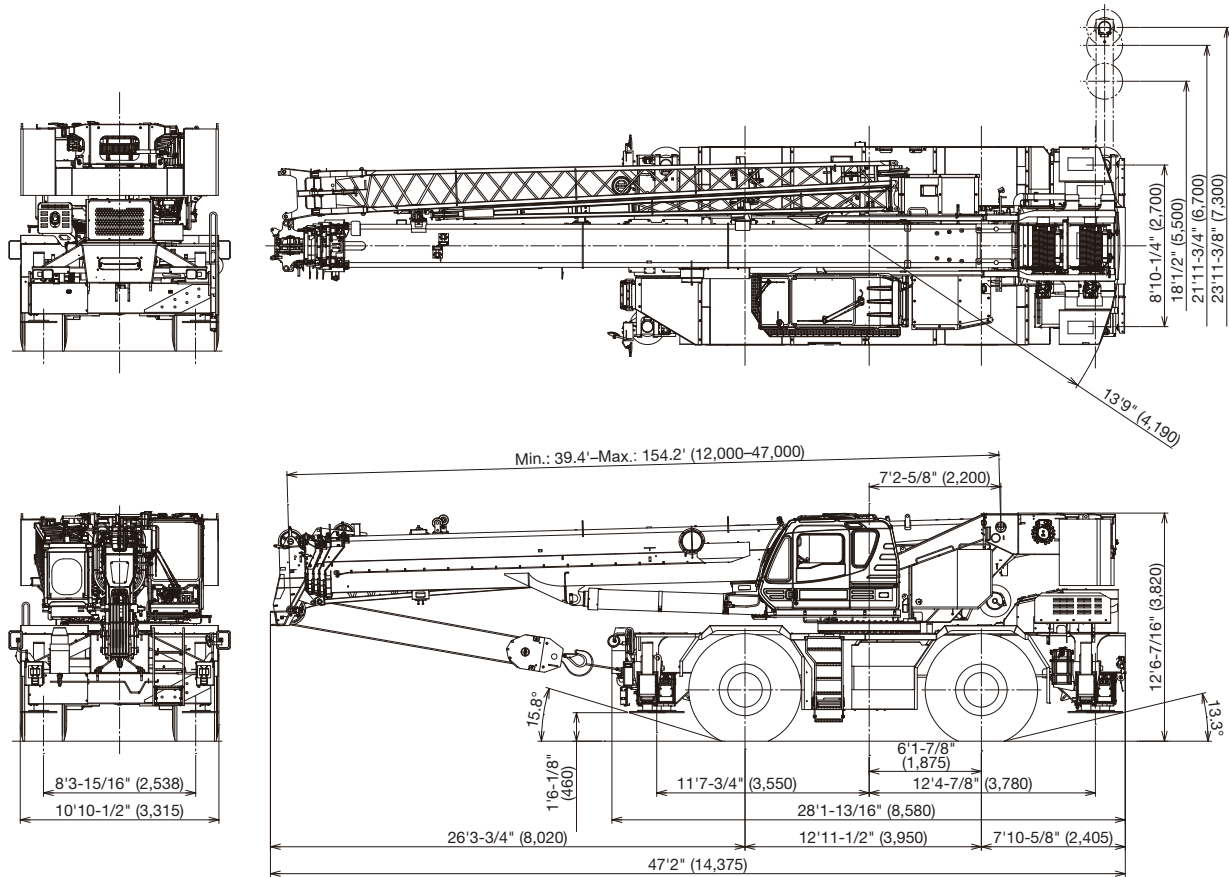

Note: Dimension is with boom angle at -1.6 degree.  
( ) Reference dimensions in mm.

### GENERAL DIMENSIONS

	Feet	Meters		Feet	Meters
Turning radius (29.5-25 Tires)			Overall length	approx. 47' 2"	14.375
4 wheel steer	22' 4"	6.8	Overall width	approx. 10' 10-1/2"	3.315
2 wheel steer	35' 9-3/32"	10.9	Overall height	approx. 12' 6-7/16"	3.820

# CRANE SPECIFICATIONS

## BOOM

5 section full power synchronized telescoping boom, 39.4'-154.2' (12.0 m-47.0 m), of round box construction with 5 sheaves, 17-5/16" (0.44 m) root diameter, at boom head.

The synchronization system consists of 2 telescope cylinders, an extension cable and retraction cable. Hydraulic cylinder fitted with holding valve. 2 easily removable wire rope guards, rope dead end provided on both sides of boom head. Boom telescope sections are supported by wear pads both vertically and horizontally. Extension speed 114.8' in 142 seconds.

**BOOM ELEVATION** - By a double acting hydraulic cylinder with holding valve. Elevation -1.5°-80.5°, combination controls for hand or foot operation. Boom angle indicator. Automatic speed reduction and slow stop function. Boom raising speed 20° to 60° in 46 seconds.

**JIB** - 2 stage bi-fold lattice type, 3.5°, 25° or 45° offset (tilt type). Single sheave, 15-5/8" (0.396 m) root diameter, at the head of both jib sections. Stored alongside base boom section. Jib length is 33.2' (10.1 m) or 58.1' (17.7 m). Assistant cylinders for mounting and stowing, controlled at right side of superstructure. Self stowing jib mounting pins.

## AUXILIARY LIFTING SHEAVE (SINGLE TOP)

Single sheave, 15-5/8" (0.396 m) root diameter. Mounted to main boom head for single line work (stowable).

**ANTI-TWO BLOCK** - Pendant type over-winding cut out device with audio-visual (FAILURE lamp/BUZZER) warning system.

## SLEWING

Hydraulic axial piston motor through planetary slewing speed reducer. Continuous 360° full circle slewing on ball bearing turn table at 1.5 min<sup>-1</sup> {rpm}. Equipped with manually locked/released slewing brake. A 360° positive slewing lock for pick and carry and travel modes, manually engaged in cab. Twin slewing system: Free slewing or lock slewing controlled by selector switch on front console.

## WINCH

**MAIN WINCH** - Variable speed type with grooved drum driven by hydraulic axial piston motor through speed reducer. Power load lowering and raising. Equipped with automatic brake (neutral brake) and counterbalance valve. Controlled independently of auxiliary winch. Equipped with cable follower and drum rotation indicator.

**DRUM** - Grooved 14-1/4" (0.362 m) root diameter x 26-13/16" (0.681 m) wide. Wire rope: 830' of 3/4" diameter rope (253 m of 19 mm). Drum capacity: 1135' (346 m) 7 layers. Maximum single line pull: 1st layer 20,000 lbs (9,090 kg). Maximum permissible line pull wire strength: 14,600 lbs (6,600 kg).

**AUXILIARY WINCH** - Variable speed type with grooved drum driven by hydraulic axial piston motor through speed reducer. Power load lowering and raising. Equipped with automatic brake (neutral brake) and counterbalance valve. Controlled independently of main winch. Equipped with cable follower and drum rotation indicator.

**DRUM** - Grooved 14-1/4" (0.362 m) root diameter x 26-13/16" (0.681 m) wide. Wire rope: 456' of 3/4" diameter rope (139 m of 19 mm). Drum capacity: 1135' (346 m) 7 layers. Maximum single line pull: 1st layer 20,000 lbs (9,090 kg). Maximum permissible line pull wire strength: 14,600 lbs (6,600 kg).

**WIRE ROPE** - Non-rotating 3/4" (19 mm) P·S (19) + 39 x P·7 Breaking Strength 72,800 lbs (33,000 kg)

## HOOK BLOCKS

80 ton (72.6 metric ton)-6 sheaves with swivel hook and safety latch, for 3/4" (19 mm) wire rope.

7.3 ton (6.6 metric ton) - Weighted hook with swivel and safety latch, for 3/4" (19 mm) wire rope.

**COUNTERWEIGHT** - 9,600 lbs (4,350 kg)

## HYDRAULIC SYSTEM

**PUMPS** - 2 variable piston pumps for crane functions. Tandem gear pump for steering slewing and other hydraulic systems. Powered by carrier engine. Pump disconnect for crane is engaged/ disengaged by rotary switch from operator's cab.

**CONTROL VALVES** - Multiple valves actuated by pilot pressure with integral pressure relief valves.

**RESERVOIR** - 210 gallon (795 lit.) capacity. External sight level gauge.

**FILTRATION** - BETA10=10 return filter, full flow with bypass protection, located inside of hydraulic reservoir. Accessible for easy replacement.

**OIL COOLER** - Air cooled fan type.

## CAB AND CONTROLS

Both crane and drive operations can be performed from one cab mounted on rotating superstructure.

20° tilt, Left side, 1 man type, steel construction with sliding door access and safety glass windows opening at side. Door window is powered control. Windshield glass window and roof glass window are shatter-resistant. Tilt-telescoping steering wheel. Adjustable control lever stands for slewing, boom elevating, boom telescoping, auxiliary winch and main winch. Control lever stands can change neutral positions and tilt for easy access to cab. 3 way adjustable operator's seat with high back, headrest and armrest. Engine throttle knob. Foot operated controls: boom elevating boom telescoping, service brake and engine throttle. Hot water cab heater and air conditioning.

Dash-mounted Instrument panel, Multi Function Display, Starter switch (engine start/stop), 12 V power outlet, USB port, drive selector switch, parking brake switch, steering mode select switch, power window switch, pump engaged/disengaged switch, slewing brake switch, telescoping/auxiliary winch select switch, outrigger controls, free slewing/lock slewing selector switch, air conditioning control switch.

Instruments panel - Torque converter oil temperature, engine water temperature, air pressure, fuel, speedometer, tachometer, hour meter and odometer/tripmeter.

Multi Function Display - DEF level gauge, Fuel consumption monitor.

Tadano electronic LOAD MOMENT INDICATOR system (AML-E2) including:

- Control lever lockout function with audible and visual pre-warning
- Number of parts of line
- Boom position indicator
- Outrigger state indicator
- Slewing angle
- Boom angle / boom length / jib offset angle / jib length / load radius / rated lifting capacities / actual loads read out
- Potential lifting height
- Ratio of actual load moment to rated load moment indication
- Automatic Speed reduction and slow stop function on boom elevation and slewing
- Working condition register switch
- Load radius / boom angle / tip height / slewing range preset function
- External warning lamp
- Tare function
- Main Hydraulic oil pressure
- Fuel consumption monitor

- Main winch / auxiliary winch select
- Drum rotation indicator (audible and visible type) main and auxiliary winch
- On rubber indicator

TADANO AML-E2 monitors outrigger extended length and automatically programs the corresponding "RATED LIFTING CAPACITIES" table.

Operator's right hand console includes transmission gear selector, slewing lock lever and sight level bubble.

Upper console includes, roof washer and wiper switch, emergency outrigger set up key switch, jib equipped / removed select switch, high speed winch (main / aux) switch, Cab tilt switch, Pump disconnect enable switch and boom emergency telescoping switch (2nd and 3rd-top).

NOTE: Each crane motion speed is based on unladen conditions.

## CARRIER SPECIFICATIONS

**TYPE** - Rear engine, left hand steering, driving axle 2-way selected type by manual switch, 4 x 2 front drive, 4 x 4 front and rear drive.

**FRAME** - High tensile steel, all welded mono-box construction.

**TRANSMISSION** - Electronically controlled full automatic transmission. Torque converter driving full powershift with driving axle selector. 6 forward and 2 reverse speeds, constant mesh.

- 3 speeds - high range - 2 wheel drive; 4 wheel drive
- 3 speeds - low range - 4 wheel drive

**TRAVEL SPEED** - 22 mph (36 km/h)

**GRADEABILITY (tanθ)** - 79% (at stall), 57%\*

\* Machine should be operated within the limit of engine crankcase design (30°: Cummins B6.7)

**AXLE** - Front: Full floating type, steering and driving axle with planetary reduction. Rear: Full floating type, steering and driving axle with planetary reduction and non-spin rear differential.

**STEERING** - Hydraulic power steering controlled by steering wheel. Four steering modes available: 2 wheel front, 2 wheel rear, 4 wheel coordinated and 4 wheel crab.

### ENGINE

Model	Cummins B6.7
Type	Direct injection diesel
No. of cylinders	6
Combustion	4 cycle, turbo charged and after cooled
BoreXStroke, in. (mm)	4.212 X 4.882 (107 X 124)
Displacement, cu. in (liters)	409 (6.7)
Air inlet heater	24 volt preheat
Air cleaner	Dry type, replaceable element
Oil filter	Full flow with replaceable element
Fuel filter	Full flow with replaceable element
Fuel tank, gal. (liters)	79.2 (300), right side of carrier
Cooling	Liquid pressurized, recirculating by-pass

**SUSPENSION** - Front: Rigid mounted to frame. Rear: Pivot mounted with hydraulic lockout device.

**BRAKE SYSTEMS** - Service: Air over hydraulic disc brakes on all 4 wheels. Parking / Emergency: Spring applied-air released brake acting on input shaft of front axle. Auxiliary: Electro-pneumatic operated exhaust brake.

**TIRES** - 29.5-25 34PR (OR) Air pressure: 57 psi (400 kPa)

**OUTRIGGERS** - Four hydraulic, beam and jack outriggers. Vertical jack cylinders equipped with integral holding valve. Each outrigger beam and jack is controlled independently from cab. Beams extend to 23' 11-3/8" (7.3 m) center-line and retract to within 10' 10-1/2" (3.315 m) overall width with floats. Outrigger jack floats are attached thus eliminating the need of manually attaching and detaching them. Controls and sight bubble located in superstructure cab. Four outrigger extension lengths are provided with corresponding "RATED LIFTING CAPACITIES" for crane duty in confined areas.

- Min. Extension 8' 10-1/4" (2.7 m) center to center
- Mid. Extension 18' 1/2" (5.5 m) center to center
- Mid. Extension 21' 11-3/4" (6.7 m) center to center
- Max. Extension 23' 11-3/8" (7.3 m) center to center

Float size (Diameter) 1' 11- 5/8" (0.6 m)

Radiator	Fin and tube core, thermostat controlled
Fan, in. (mm)	Suction type, 9-blade, 28 (711) dia.
Starting	24 volt
Charging	24 volt system, negative ground
Battery	2-120 amp. Hour
Compressor, air, CFM (l /min)	17.0 CFM (481) at 2,400 rpm
Output, Max. HP (kW)	Gross 280 (209) at 2,200 rpm
Torque, Max. ft-lb (Nm)	850 (1,152) at 1,500 rpm
Capacity, gal. (liters)	
Cooling water	2.7 (10)
Lubrication	4.0 (15)
Fuel	79.2 (300)
DEF/AdBlue	15.0 (57)

# STANDARD EQUIPMENT

- 5 section full power partially synchronized boom  
39.4'-154.2' (12.0 m-47.0 m)
- 33.2' or 58.1' (10.1 m or 17.7 m) bi-fold lattice jib (tilt type)  
with 3.5°, 25° or 45° pinned offsets and self storing pins.
- Quick reeving type bi-fold jib
- Anti-Two block device (overwind cutout)
- Winch drum camera with light
- LED work lights
- Variable speed main winch with grooved drum, cable follower, drum  
rotation indicator (audible, visible and thumper type) and 830' of 3/4" cable.
- Variable speed auxiliary winch with grooved drum, cable follower, drum  
rotation indicator (audible, visible and thumper type) and 456' of 3/4" cable.
- Auxiliary lifting sheave (single top) stowable
- 2-speed winch
- 80 ton (72.6 metric ton) hook block - 6 sheaves with swivel hook  
and safety  
latch for 3/4" (19 mm) wire rope
- 7.3 ton (6.6 metric ton) hook with swivel
- Tadano twin slewing system and 360° positive slewing lock
- Positive control
- Hydraulic oil cooler
- 3 way adjustable cloth seat with armrests, high back and seat belt
- Tilt-telescoping steering wheel
- Tinted safety glass and sun visor
- Front windshield wiper and washer
- Roof window wiper and washer
- Power window (cab door)
- 12V power outlet
- Ashtray
- Cab floor mat
- Pump disconnect in operator's cab
- Air conditioner (hot water heater and cooler)
- Full instrumentation package
- Self centering finger control levers with pilot control
- Control pedals for boom elevating and boom telescoping
- Low oil pressure / high water temp. warning device (visual)
- Air cleaner dust indicator
- Cup holder
- Battery disconnect
- USB port
- 20° tilt cab
- Emergency steering system
- Tadano electronic load moment indicator system (AML-E2)
- Boom angle indicator
- Outrigger extension length detector
- Electronic crane monitoring system
- Rear view camera
- Right front view camera
- Fenders
- Air dryer
- Complete highway light package
- Towing hooks-Front and rear
- Hook block tie down (front bumper)
- Weighted hook storage compartment
- Halogen head lamp
- Independently controlled outriggers
- Four outrigger extension positions
- Self-storing outrigger pads
- Electronic controlled automatic transmission driven by torque converter
- 4 X 4 X 4 drive / steer
- Non-spin rear differential
- Automatic rear axle oscillation lockout system
- 29.5-25 34 PR tires
- Disc brakes
- Water separator with filter (high filtration)
- Back-up alarm
- 24 volt electric system
- Tool storage compartment
- Tire inflation kit
- Cummins B6.7 turbo charged  
after cooled engine (280 HP) with exhaust brake
- Engine over-run alarm
- Lifting eyes
- Telematics (machine data logging and monitoring system)  
with HELLO-NET via internet (availability depends on countries)
- Fuel consumption monitor
- Eco mode system
- Radiator cover
- Clearance sonar (Rear side)
- Automatic pump disconnect
- Over unwinding prevention

# HOISTING PERFORMANCE

## LINE SPEEDS AND PULLS

Layer	Main or auxiliary hoist - 14'-1/4" (0.362 m) drum							
	Line speeds <sup>1</sup>				Line pulls Available <sup>2</sup>			
	Low		High		Low		High	
	F.P.M	m/min	F.P.M	m/min	Lbs.	kgf	Lbs.	kgf
1st	278	84	387	118	20,000	9,090	14,400	6,520
2nd	302	92	421	128	18,100	8,230	13,000	5,900
3rd	327	99	456	139	16,600	7,520	11,900	5,390
4th	352	107	491	149	15,300	6,920	10,900	4,960
5th	377	115	526	160	14,100	6,410	10,100	4,600
6th	402	122	560	170	13,200	5,970	9,400	4,280
7th <sup>3</sup>	427	130	595	181	12,300	5,590	8,800	4,010

- Maximum permissible line pull wire strength  
14,600 lbs (6,600 kg).

<sup>1</sup> Line speeds based only on hook block, not loaded.  
<sup>2</sup> Developed by machinery with each layer of wire rope, but not based  
on rope strength or other limitation in machinery or equipment.  
<sup>3</sup> Seventh layer of wire rope are not recommended  
for hoisting operations.

## DRUM WIRE ROPE CAPACITIES

Wire rope layer	Main and auxiliary drum grooved lagging 3/4" (19 mm) wire rope			
	Rope per layer m		Total wire rope m	
	Feet	Meters	Feet	Meters
1	128.0	39.0	128.0	39.0
2	139.4	42.5	267.4	81.5
3	150.9	46.0	418.3	127.5
4	162.1	49.4	580.4	176.9
5	173.9	53.0	754.3	229.9
6	185.4	56.5	939.6	286.4
7	196.9	60.0	1,136.5	346.4

## DRUM DIMENSIONS

	Inch	mm
Root diameter	14-1/4"	362
Length Flange diameter	26-13/16"	681
	25-7/8"	657

# GR-800XL-4 WORKING RANGE CHART

360° ROTATION

Unit: klbs

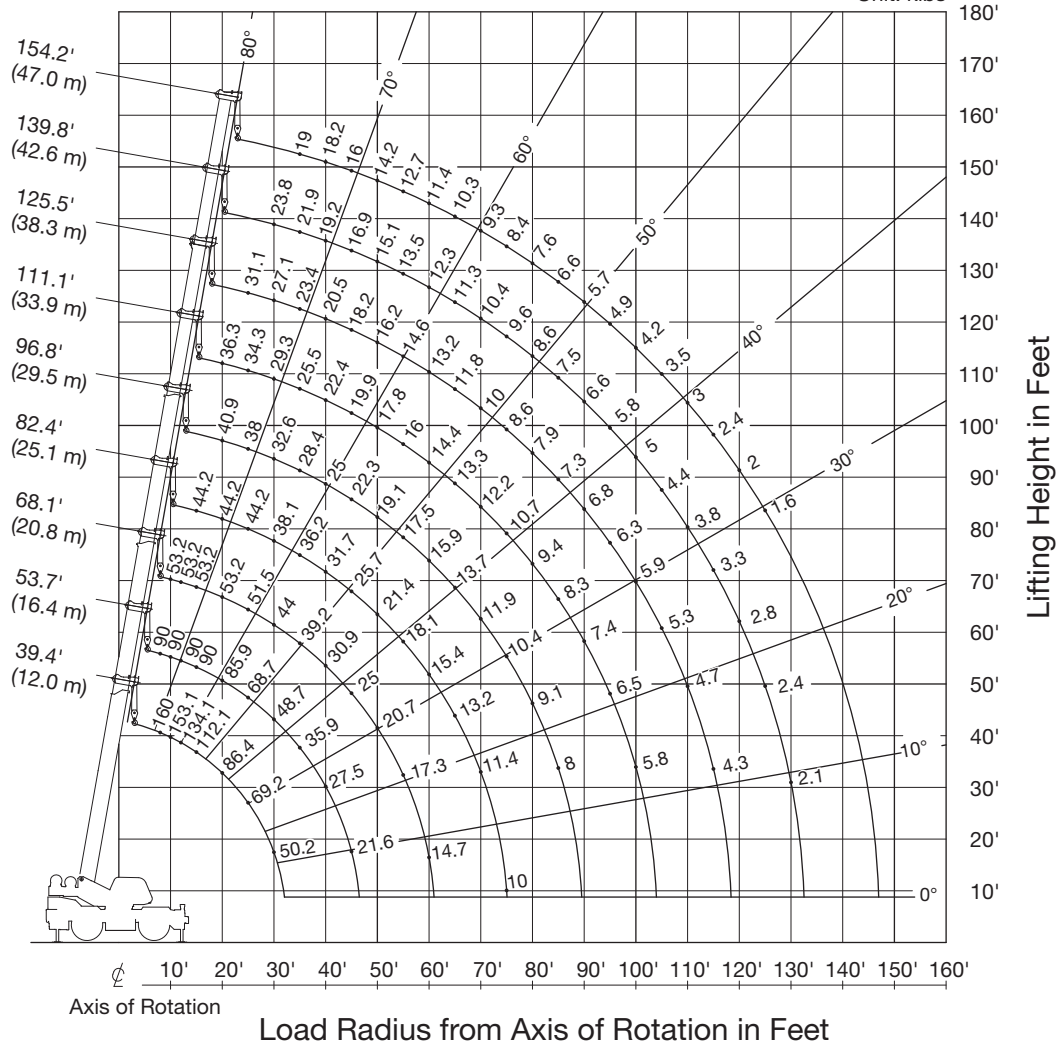

BOOM

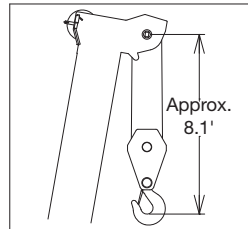

SINGLE TOP

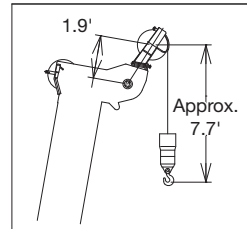

NOTE: Boom geometry shown is for unloaded condition and machine standing level on firm supporting surface. Boom deflection and subsequent radius and boom angle change must be accounted for when applying load to hook. When boom length is same as telescoping mode 1 and 2, it show large load.

# GR-800XL-4 WORKING RANGE CHART

## SMART CHART

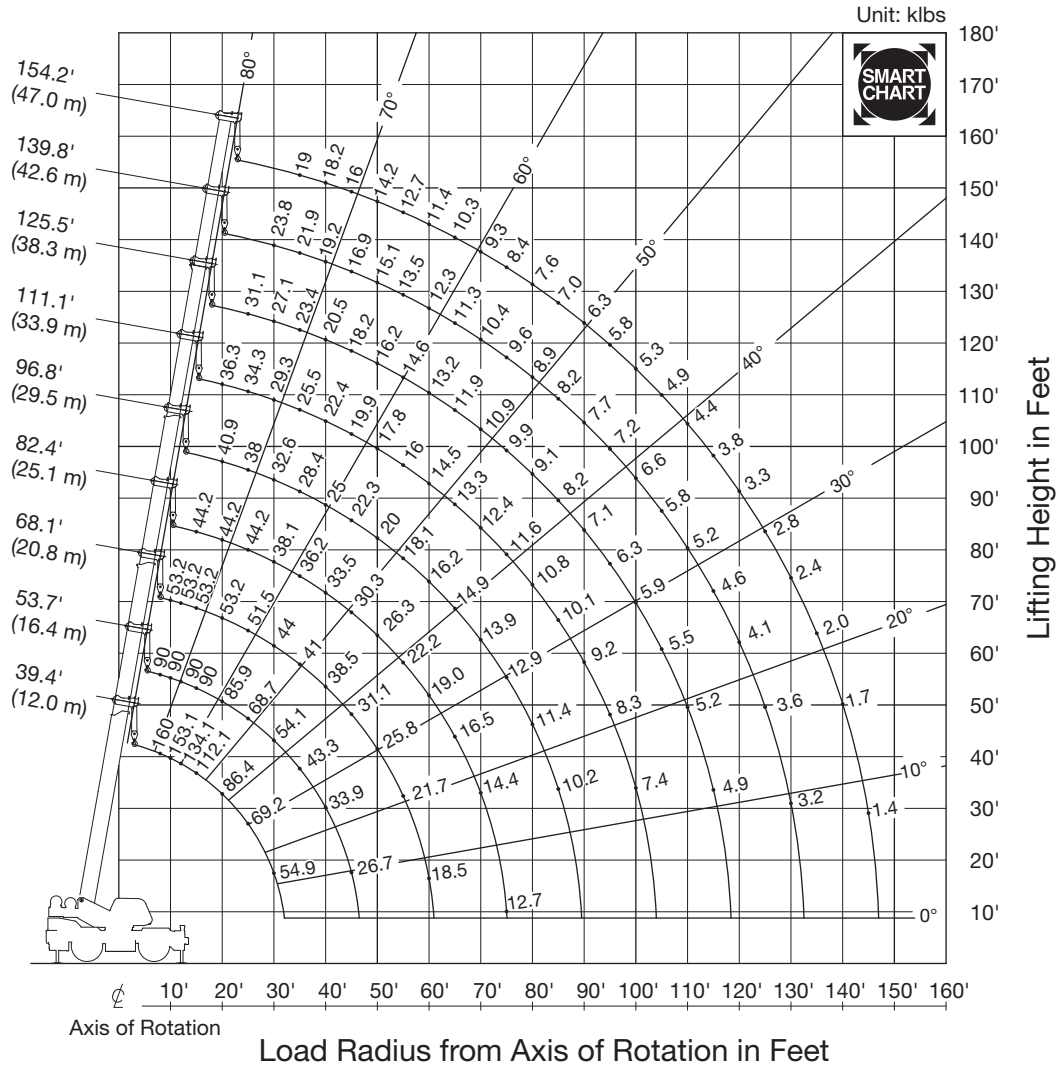

BOOM

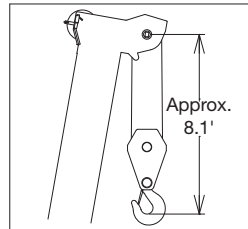

SINGLE TOP

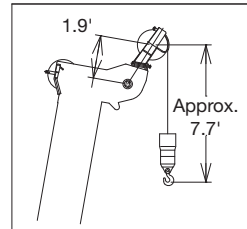

NOTE: Boom geometry shown is for unloaded condition and machine standing level on firm supporting surface. Boom deflection and subsequent radius and boom angle change must be accounted for when applying load to hook. When boom length is same as telescoping mode 1 and 2, it show large load.



# GR-800XL-4 WORKING RANGE CHART

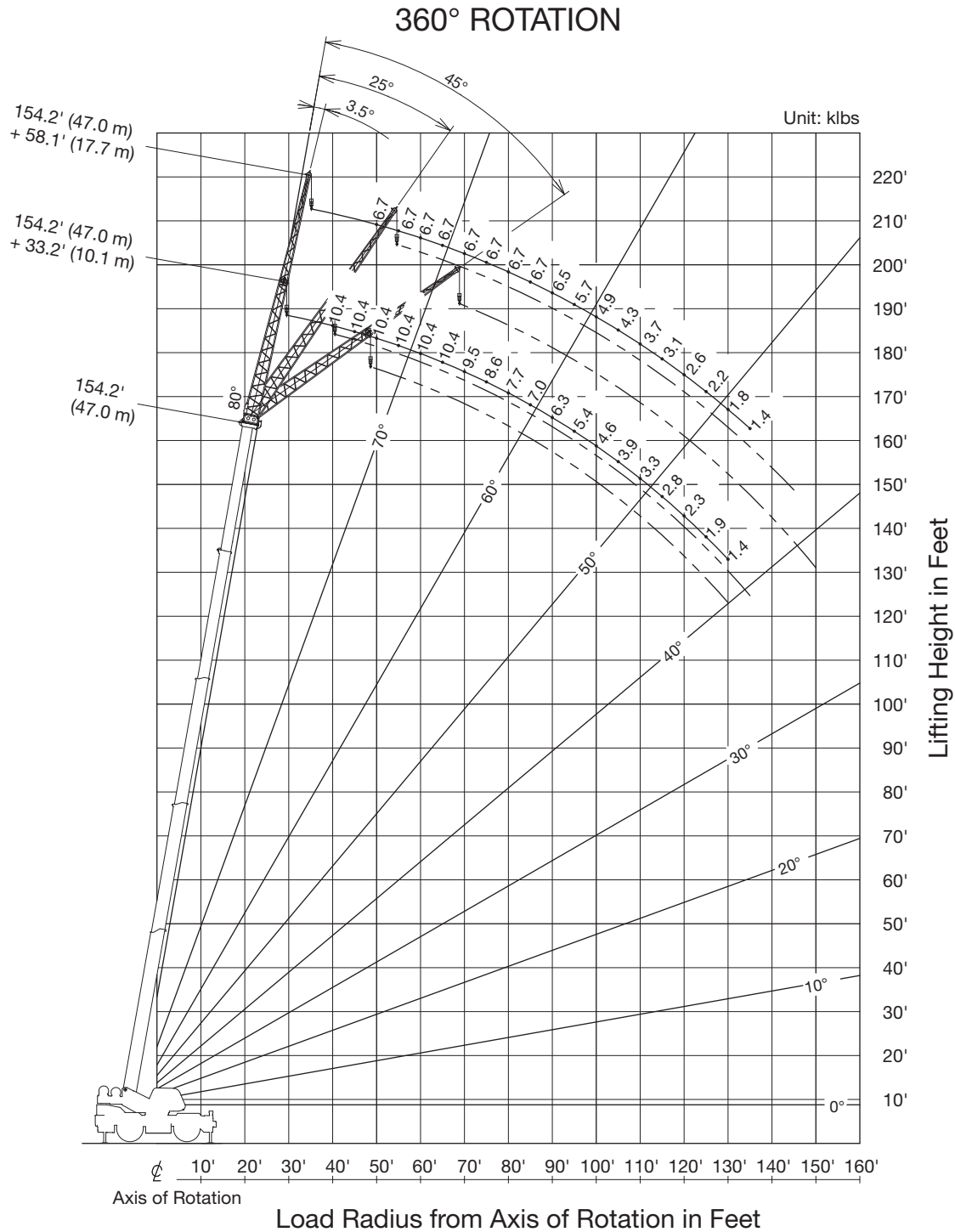

NOTE: Jib geometry shown is for unloaded condition and machine standing level on firm supporting surface. Boom deflection and subsequent radius and boom angle change must be accounted for when applying load to hook.

JIB

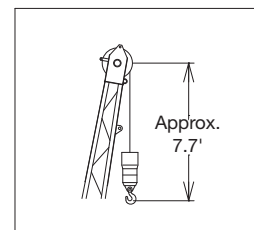

# GR-800XL-4 WORKING RANGE CHART

## SMART CHART

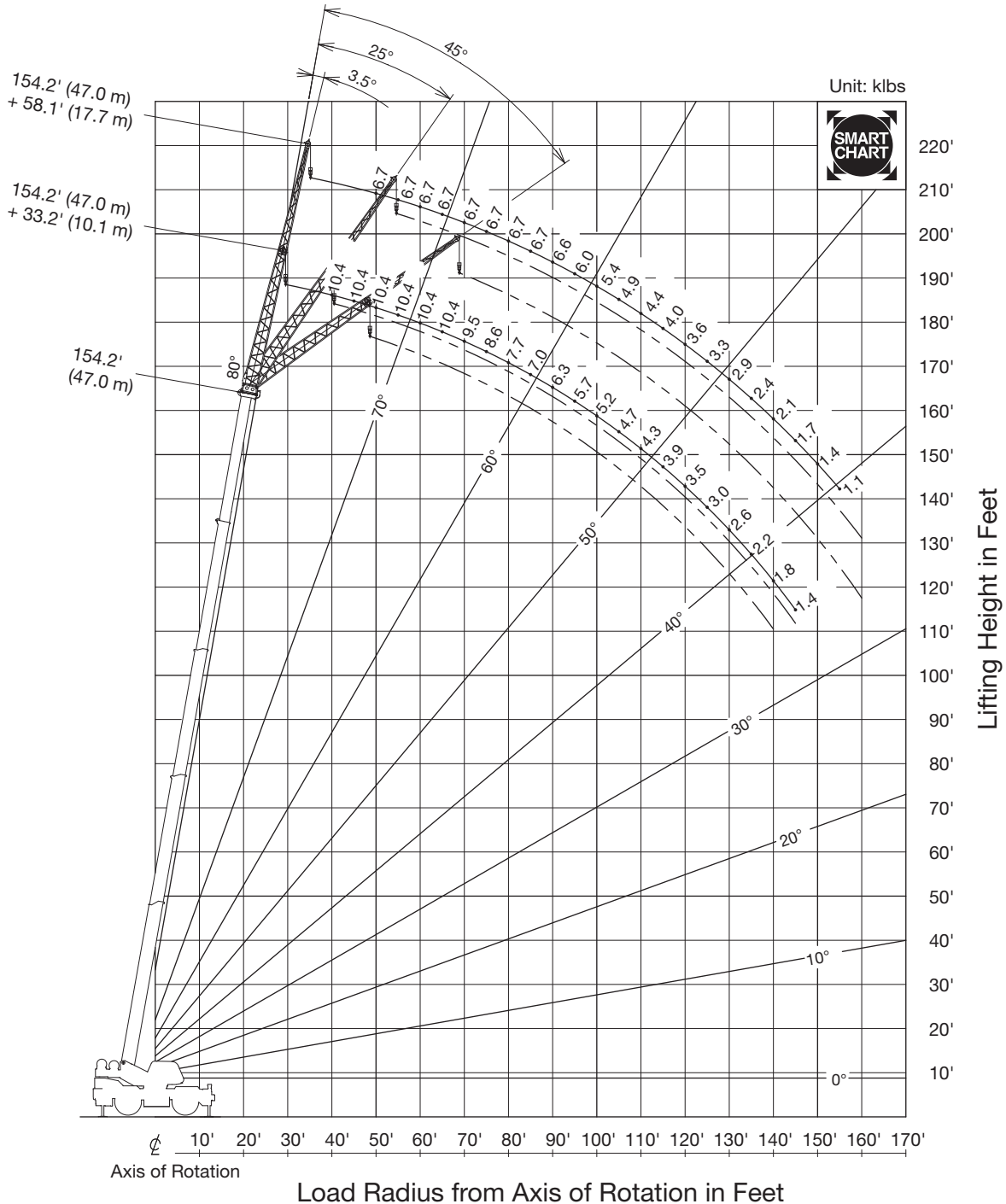

NOTE: Jib geometry shown is for unloaded condition and machine standing level on firm supporting surface. Boom deflection and subsequent radius and boom angle change must be accounted for when applying load to hook.

JIB

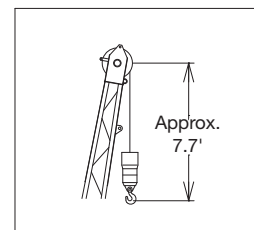



# GR-800XL-4 RATED LIFTING CAPACITIES (IN POUNDS)

COUNTERWEIGHT 9,600 lbs (4.35 t)															
ON OUTRIGGERS FULLY EXTENDED 23' 11-3/8" (7.3 m) SPREAD															
360° ROTATION															
B \ A	39.4'	53.7'	68.1'		82.4'		96.8'		111.1'		125.5'		139.8'		154.2'
	(12 m)	(16.4 m)	(20.8 m)		(25.1 m)		(29.5 m)		(33.9 m)		(38.3 m)		(42.6 m)		(47 m)
8	160,000	90,000													
10	153,100	90,000	53,200	41,000											
12	134,100	90,000	53,200	41,000											
15	112,100	90,000	53,200	41,000	44,200	36,200									
20	86,400	85,900	53,200	41,000	44,200	36,200	40,900	34,300	36,300	33,300					
25	69,200	68,700	51,500	41,000	44,200	36,200	38,000	33,800	34,300	30,600	31,100	26,200			
30	50,200	48,700	44,000	41,000	38,100	36,200	32,600	29,400	29,300	26,600	27,100	22,400	23,800	22,300	
35		35,900	35,100	39,200	33,000	36,200	28,400	26,000	25,500	23,500	23,400	19,500	21,900	20,900	19,000
40		27,500	26,900	30,900	28,300	31,700	25,000	23,200	22,400	21,000	20,500	17,200	19,200	18,500	18,200
45		21,600	21,100	25,000	22,400	25,700	22,300	21,000	19,900	18,900	18,200	15,300	16,900	16,500	16,000
50			16,800	20,700	18,100	21,400	18,900	19,100	17,800	17,200	16,200	13,700	15,100	14,900	14,200
55			13,500	17,300	14,900	18,100	15,600	17,500	16,000	15,700	14,600	12,300	13,500	13,500	12,700
60			10,900	14,700	12,200	15,400	13,000	15,900	13,500	14,400	13,200	11,200	12,100	12,300	11,400
65					10,100	13,200	10,900	13,700	11,400	13,300	11,800	10,200	11,000	11,300	10,300
70					8,400	11,400	9,200	11,900	9,700	12,200	10,000	9,300	10,000	10,400	9,300
75					6,900	10,000	7,700	10,400	8,200	10,700	8,600	8,600	8,800	9,600	8,400
80							6,400	9,100	7,000	9,400	7,300	7,900	7,600	8,600	7,600
85							5,400	8,000	5,900	8,300	6,200	7,300	6,500	7,500	6,600
90									5,000	7,400	5,300	6,800	5,600	6,600	5,700
95									4,100	6,500	4,500	6,300	4,700	5,800	4,900
100									3,400	5,800	3,800	5,900	4,000	5,000	4,200
105											3,100	5,300	3,400	4,400	3,500
110											2,600	4,700	2,800	3,800	3,000
115											2,100	4,300	2,300	3,300	2,400
120													1,800	2,800	2,000
125													1,400	2,400	1,600
130														2,100	
D	0°												13°	0°	33°
Telescoping mode	1, 2	1	1	2	1	2	1	2	1	2	1	2	1	2	1, 2
2nd Boom	0	50	100	0	100	0	100	0	100	0	100	0	100	50	100
3rd Boom	0	0	0	33	16	50	33	67	50	83	67	100	83	100	100
4th Boom	0	0	0	33	16	50	33	67	50	83	67	100	83	100	100
Top Boom	0	0	0	33	16	50	33	67	50	83	67	100	83	100	100

COUNTERWEIGHT 9,600 lbs (4.35 t)																											
ON OUTRIGGERS FULLY EXTENDED 23' 11-3/8" (7.3 m) SPREAD																											
360° ROTATION																											
C \ A	39.4'		53.7'		68.1'		82.4'		96.8'		111.1'		125.5'		139.8'												
	B	(12 m)	B	(16.4 m)	B	(20.8 m)	B	(25.1 m)	B	(29.5 m)	B	(33.9 m)	B	(38.3 m)	B	(42.6 m)											
0°	32.5	25,900	46.8	15,100	61.1	8,900	61.0	12,500	75.3	6,200	75.3	9,300	89.4	4,400	89.5	7,100	103.6	3,000	103.3	5,400	117.8	1,900	117.3	3,700	131.4	2,000	
Telescoping mode	1, 2		1		1		2		1		2		1		2											2	

- A: Boom length in feet
- B: Load radius in feet
- C: Loaded boom angle (°)
- D: Minimum boom angle (°) for indicated length (no load)

NOTE: The lifting capacity data stored in the LOAD MOMENT INDICATOR (AML-E2) is based on the standard number of parts of line listed in the chart. Standard number of parts of line for each boom length should be according to the following table.

Boom length in feet (meters)	39.4' (12 m)	39.4' to 53.7' (12 m to 16.4 m)	53.7' to 154.2' (16.4 m to 47 m)	Single top jib
Telescoping mode	1, 2	1	2	1, 2
Number of parts of line	12	8	4	1

# GR-800XL-4 RATED LIFTING CAPACITIES (IN POUNDS)

COUNTERWEIGHT 9,600 lbs (4.35 t)																		
ON OUTRIGGERS FULLY EXTENDED 23' 11-3/8" (7.3 m) SPREAD																		
SMART CHART																		
B	A	39.4' (12 m)	53.7' (16.4 m)	68.1' (20.8 m)		82.4' (25.1 m)		96.8' (29.5 m)		111.1' (33.9 m)		125.5' (38.3 m)		139.8' (42.6 m)		154.2' (47 m)		
	8		160,000	90,000														
10		153,100	90,000	53,200	41,000													
12		134,100	90,000	53,200	41,000													
15		112,100	90,000	53,200	41,000	44,200	36,200											
20		86,400	85,900	53,200	41,000	44,200	36,200	40,900	34,300	36,300	33,300							
25		69,200	68,700	51,500	41,000	44,200	36,200	38,000	33,800	34,300	30,600	31,100	26,200					
30		54,900	54,100	44,000	41,000	38,100	36,200	32,600	29,400	29,300	26,600	27,100	22,400	23,800	22,300			
35			43,300	38,300	41,000	33,000	36,200	28,400	26,000	25,500	23,500	23,400	19,500	21,900	20,900	19,000		
40			33,900	33,100	38,500	29,000	33,500	25,000	23,200	22,400	21,000	20,500	17,200	19,200	18,500	18,200		
45				26,700	26,000	31,100	25,700	30,300	22,300	21,000	19,900	18,900	18,200	15,300	16,900	16,500	16,000	
50					20,900	25,800	22,300	26,300	20,000	19,100	17,800	17,200	16,200	13,700	15,100	14,900	14,200	
55					17,000	21,700	18,400	22,200	18,100	17,500	16,000	15,700	14,600	12,300	13,500	13,500	12,700	
60					13,900	18,500	15,300	19,000	16,200	16,100	14,500	14,400	13,200	11,200	12,100	12,300	11,400	
65							12,900	16,500	13,700	14,900	13,200	13,300	11,900	10,200	11,000	11,300	10,300	
70							10,800	14,400	11,700	13,900	12,100	12,400	10,900	9,300	10,000	10,400	9,300	
75							9,100	12,700	10,000	12,900	10,500	11,600	9,900	8,600	9,100	9,600	8,400	
80									8,500	11,400	9,100	10,800	9,100	7,900	8,300	8,900	7,600	
85									7,300	10,200	7,800	10,100	8,200	7,300	7,600	8,200	7,000	
90											6,800	9,200	7,100	6,800	6,900	7,700	6,300	
95											5,800	8,300	6,200	6,300	6,400	7,200	5,800	
100											5,000	7,400	5,400	5,900	5,600	6,600	5,300	
105													4,600	5,500	4,900	5,800	4,900	
110													4,000	5,200	4,200	5,200	4,400	
115													3,400	4,900	3,600	4,600	3,800	
120															3,100	4,100	3,300	
125															2,700	3,600	2,800	
130															2,300	3,200	2,400	
135																	2,000	
140																	1,700	
145																	1,400	
D																	0°	13°
Telescoping mode		1, 2	1	1	2	1	2	1	2	1	2	1	2	1	2	1	2	1, 2
2nd Boom		0	50	100	0	100	0	100	0	100	0	100	0	100	50	100	100	100
3rd Boom		0	0	0	33	16	50	33	67	50	83	67	100	83	100	100	100	100
4th Boom		0	0	0	33	16	50	33	67	50	83	67	100	83	100	100	100	100
Top Boom		0	0	0	33	16	50	33	67	50	83	67	100	83	100	100	100	100

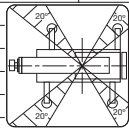

COUNTERWEIGHT 9,600 lbs (4.35 t)																													
ON OUTRIGGERS FULLY EXTENDED 23' 11-3/8" (7.3 m) SPREAD																													
SMART CHART																													
C	A	39.4' (12 m)		53.7' (16.4 m)		68.1' (20.8 m)		82.4' (25.1 m)		96.8' (29.5 m)		111.1' (33.9 m)		125.5' (38.3 m)		139.8' (42.6 m)													
		B	(12 m)	B	(16.4 m)	B	(20.8 m)	B	(20.8 m)	B	(25.1 m)	B	(25.1 m)	B	(29.5 m)	B	(29.5 m)	B	(33.9 m)	B	(33.9 m)	B	(38.3 m)	B	(38.3 m)	B	(42.6 m)	B	(42.6 m)
0°		32.5	25,900	46.8	15,100	61.1	8,900	61.0	12,500	75.3	6,200	75.3	9,300	89.4	4,500	89.5	7,100	103.7	3,100	103.4	5,600	117.8	2,200	117.2	4,200	131.9	1,400	131.3	2,600
Telescoping mode		1, 2		1		1		2		1		2		1		2		1		2		1		2		1		2	

- A: Boom length in feet
- B: Load radius in feet
- C: Loaded boom angle (°)
- D: Minimum boom angle (°) for indicated length (no load)

NOTE: The lifting capacity data stored in the LOAD MOMENT INDICATOR (AML-E2) is based on the standard number of parts of line listed in the chart. Standard number of parts of line for each boom length should be according to the following table.

Boom length in feet (meters)	39.4' (12 m)	39.4' to 53.7' (12 m to 16.4 m)	53.7' to 154.2' (16.4 m to 47 m)	Single top jib
Telescoping mode	1, 2	1	2	1, 2
Number of parts of line	12	8	4	1

# GR-800XL-4 RATED LIFTING CAPACITIES (IN POUNDS)

COUNTERWEIGHT 9,600 lbs (4.35 t) ON OUTRIGGERS FULLY EXTENDED 23' 11-3/8" (7.3 m) SPREAD 360° ROTATION							
B	154.2' (47 m) Boom + 33.2' (10.1 m) JIB			B	154.2' (47 m) Boom + 58.1' (17.7 m) JIB		
	3.5° Offset	25° Offset	45° Offset		3.5° Offset	25° Offset	45° Offset
40	10,400			40			
45	10,400			45			
50	10,400			50	6,700		
55	10,400			55	6,700		
60	10,400	10,200		60	6,700		
65	10,400	10,200	8,800	65	6,700		
70	9,500	9,600	8,800	70	6,700		
75	8,600	8,800	8,400	75	6,700	6,000	
80	7,700	8,000	8,000	80	6,700	5,800	
85	7,000	7,300	7,400	85	6,700	5,700	4,800
90	6,300	6,600	6,700	90	6,500	5,500	4,700
95	5,400	6,000	6,200	95	5,700	5,400	4,600
100	4,600	5,400	5,600	100	4,900	5,300	4,500
105	3,900	4,700	5,100	105	4,300	5,200	4,400
110	3,300	4,000	4,500	110	3,700	4,900	4,300
115	2,800	3,400	3,800	115	3,100	4,300	4,200
120	2,300	2,900	3,200	120	2,600	3,700	4,100
125	1,900	2,400	2,700	125	2,200	3,200	3,900
130	1,400	1,900	2,200	130	1,800	2,700	3,300
135		1,500		135	1,400	2,200	2,800
140				140		1,800	2,400
145				145		1,500	1,900
150				150			1,500
Telescoping mode	1, 2	1, 2	1, 2	Telescoping mode	1, 2	1, 2	1, 2

COUNTERWEIGHT 9,600 lbs (4.35 t) ON OUTRIGGERS FULLY EXTENDED 23' 11-3/8" (7.3 m) SPREAD 360° ROTATION										
B	139.8' (42.6 m) Boom + 33.2' (10.1 m) JIB				B	139.8' (42.6 m) Boom + 58.1' (17.7 m) JIB				
	3.5° Offset	25° Offset	45° Offset			3.5° Offset	25° Offset	45° Offset		
35	10,400	11,500			35					
40	10,400	11,500			40	6,700				
45	10,400	11,500			45	6,700	7,200			
50	10,400	11,500			50	6,700	7,200			
55	10,400	11,500	10,200	10,900	55	6,700	7,200			
60	10,400	11,400	10,200	10,600	60	6,700	7,200			
65	10,400	10,400	10,200	9,800	65	6,700	7,200	6,000		
70	9,900	9,400	10,100	9,100	70	6,700	7,200	6,000	6,200	
75	8,900	8,600	9,100	8,500	75	6,700	7,200	6,000	6,000	
80	8,100	7,900	8,300	7,800	80	6,700	7,200	6,000	5,900	
85	7,400	7,300	7,600	7,300	85	6,700	7,000	5,800	5,700	
90	6,500	6,700	6,900	6,700	90	6,700	6,400	5,600	5,600	
95	5,600	6,200	6,400	6,200	95	6,000	5,900	5,500	5,400	
100	4,800	5,700	5,600	5,800	100	5,200	5,400	5,400	5,200	
105	4,100	5,000	4,800	5,400	105	4,500	5,000	5,200	5,000	
110	3,500	4,300	4,100	4,900	110	3,900	4,700	5,100	4,700	
115	2,900	3,800	3,500	4,300	115	3,400	4,100	4,500	4,400	
120	2,400	3,300	3,000	3,700	120	2,900	3,600	3,900	4,100	
125	2,000	2,800	2,400	3,200	125	2,400	3,100	3,300	3,800	
130	1,500	2,400	2,000	2,800	130	2,000	2,700	2,800	3,500	
135	1,200	2,000	1,500	2,300	135	1,600	2,300	2,400	2,900	
140		1,700	1,100	2,000	140	1,300	2,000	2,000	2,400	
145		1,300		1,600	145		1,700	1,600	2,000	
150					150		1,400	1,200	1,900	
155					155		1,100		1,600	
160					160				1,300	
Telescoping mode	1	2	1	2	1	2	1	2	1	2

COUNTERWEIGHT 9,600 lbs (4.35 t) ON OUTRIGGERS FULLY EXTENDED 23' 11-3/8" (7.3 m) SPREAD 360° ROTATION										
B	125.5' (38.3 m) Boom + 33.2' (10.1 m) JIB				B	125.5' (38.3 m) Boom + 58.1' (17.7 m) JIB				
	3.5° Offset	25° Offset	45° Offset			3.5° Offset	25° Offset	45° Offset		
35	14,600	11,500			35					
40	14,600	11,500			40		7,200			
45	14,600	11,500	12,600	10,900	45	8,700	7,200			
50	14,600	11,500	12,600	10,900	50	8,700	7,200			
55	14,200	11,500	12,500	10,900	55	8,700	7,200			
60	12,800	10,500	12,000	10,100	60	8,700	7,200			
65	11,500	9,500	11,600	9,300	65	8,700	7,200	6,700	6,300	
70	10,400	8,600	10,500	8,600	70	8,500	7,200	6,400	6,300	
75	9,500	7,900	9,600	7,900	75	8,100	7,200	6,200	6,100	
80	8,700	7,200	8,800	7,300	80	7,800	7,000	6,000	5,900	
85	7,600	6,600	8,100	6,700	85	7,500	6,400	5,900	5,700	
90	6,600	6,100	7,400	6,200	90	7,200	5,900	5,700	5,600	
95	5,700	5,600	6,400	5,700	95	6,300	5,400	5,500	5,300	
100	4,900	5,100	5,600	5,200	100	5,500	5,000	5,300	5,000	
105	4,200	4,700	4,800	4,800	105	4,800	4,600	5,200	4,700	
110	3,600	4,400	4,100	4,500	110	4,200	4,200	5,000	4,400	
115	3,000	4,000	3,500	4,100	115	3,600	3,900	4,700	4,100	
120	2,500	3,700	3,000	3,800	120	3,100	3,600	4,000	3,800	
125	2,100	3,400	2,400	3,500	125	2,600	3,300	3,500	3,500	
130	1,700	3,200	2,000	3,200	130	2,200	3,000	3,000	3,200	
135	1,300	2,800	1,500	3,000	135	1,800	2,800	2,500	3,000	
140		2,500	1,100	2,600	140	1,500	2,600	2,100	2,700	
145		2,200			145	1,100	2,400	1,700	2,500	
150					150		2,200	1,300	2,300	
155					155		2,000		2,100	
160					160		1,700		1,900	
Telescoping mode	1	2	1	2	1	2	1	2	1	2

B: Load radius in feet

# GR-800XL-4 RATED LIFTING CAPACITIES (IN POUNDS)

SMART CHART		COUNTERWEIGHT 9,600 lbs (4.35 t) ON OUTRIGGERS FULLY EXTENDED 23' 11-3/8" (7.3 m) SPREAD					
		154.2' (47 m) Boom + 33.2' (10.1 m) JIB			154.2' (47 m) Boom + 58.1' (17.7 m) JIB		
B	3.5° Offset	25° Offset	45° Offset	B	3.5° Offset	25° Offset	45° Offset
40	10,400			40			
45	10,400			45			
50	10,400			50	6,700		
55	10,400			55	6,700		
60	10,400	10,200		60	6,700		
65	10,400	10,200		65	6,700		
70	9,500	9,600		70	6,700		
75	8,600	8,800		75	6,700	6,000	
80	7,700	8,000		80	6,700	5,800	
85	7,000	7,300	8,800	85	6,700	5,700	4,800
90	6,300	6,600	8,800	90	6,600	5,500	4,700
95	5,700	6,000	8,800	95	6,000	5,400	4,600
100	5,200	5,500	8,800	100	5,400	5,300	4,500
105	4,700	5,000	8,800	105	4,900	5,200	4,400
110	4,300	4,500	8,800	110	4,400	4,900	4,300
115	3,900	4,100	8,800	115	4,000	4,500	4,200
120	3,500	3,700	8,800	120	3,600	4,100	4,100
125	3,000	3,400	8,800	125	3,300	3,700	3,900
130	2,600	3,000	8,800	130	2,900	3,400	3,600
135	2,200	2,600	8,800	135	2,400	3,100	3,300
140	1,800	2,200	8,800	140	2,100	2,800	3,000
145	1,400	1,800	8,800	145	1,700	2,400	2,600
150			8,800	150	1,400	2,100	2,400
155			8,800	155	1,100	1,700	2,100
160			8,800	160		1,400	1,700
Telescoping mode	1, 2	1, 2	1, 2	Telescoping mode	1, 2	1, 2	1, 2

SMART CHART		COUNTERWEIGHT 9,600 lbs (4.35 t) ON OUTRIGGERS FULLY EXTENDED 23' 11-3/8" (7.3 m) SPREAD						
		139.8' (42.6 m) Boom + 33.2' (10.1 m) JIB			139.8' (42.6 m) Boom + 58.1' (17.7 m) JIB			
B	3.5° Offset	25° Offset	45° Offset	B	3.5° Offset	25° Offset	45° Offset	
35	10,400	11,500		35				
40	10,400	11,500		40	6,700			
45	10,400	11,500		45	6,700	7,200		
50	10,400	11,500	10,200	50	6,700	7,200		
55	10,400	11,500	10,200	55	6,700	7,200		
60	10,400	11,400	10,200	60	6,700	7,200		
65	10,400	10,400	10,200	65	6,700	7,200		
70	9,900	9,400	10,100	70	6,700	7,200	6,000	
75	8,900	8,600	9,100	75	6,700	7,200	6,000	
80	8,100	7,900	8,300	80	6,700	7,200	6,000	
85	7,400	7,300	7,600	85	6,700	7,000	5,800	
90	6,700	6,700	6,900	90	6,700	6,400	5,600	
95	6,100	6,200	6,400	95	6,200	5,900	5,500	
100	5,600	5,800	5,800	100	5,700	5,400	5,200	
105	5,100	5,300	5,300	105	5,200	5,000	5,000	
110	4,700	5,000	4,900	110	4,700	4,700	5,100	
115	4,300	4,600	4,500	115	4,300	4,300	4,700	
120	3,700	4,300	4,100	120	3,900	4,000	4,300	
125	3,200	4,000	3,700	125	3,600	3,700	4,000	
130	2,700	3,500	3,200	130	3,100	3,500	3,600	
135	2,300	3,100	2,700	135	2,700	3,200	3,300	
140	1,900	2,700	2,200	140	2,300	3,000	3,100	
145	1,600	2,300	1,800	145	1,900	2,700	2,900	
150		2,000		150	1,600	2,400	2,700	
155		1,700		155	1,300	2,100	2,500	
160				160		1,800	2,200	
Telescoping mode	1	2	1	2	1	2	1	2

SMART CHART		COUNTERWEIGHT 9,600 lbs (4.35 t) ON OUTRIGGERS FULLY EXTENDED 23' 11-3/8" (7.3 m) SPREAD						
		125.5' (38.3 m) Boom + 33.2' (10.1 m) JIB			125.5' (38.3 m) Boom + 58.1' (17.7 m) JIB			
B	3.5° Offset	25° Offset	45° Offset	B	3.5° Offset	25° Offset	45° Offset	
30				30				
35	14,600	11,500		35				
40	14,600	11,500		40		7,200		
45	14,600	11,500	12,600	45	8,700	7,200		
50	14,600	11,500	12,600	50	8,700	7,200		
55	14,200	11,500	12,500	55	8,700	7,200		
60	12,800	10,500	12,000	60	8,700	7,200		
65	11,500	9,500	11,600	65	8,700	7,200		
70	10,400	8,600	10,500	70	8,500	7,200	6,700	
75	9,500	7,900	9,600	75	8,100	7,200	6,400	
80	8,700	7,200	8,800	80	7,800	7,000	6,200	
85	7,900	6,800	8,100	85	7,500	6,400	5,900	
90	7,300	6,100	7,400	90	7,200	5,900	5,700	
95	6,700	5,600	6,800	95	6,600	5,400	5,500	
100	6,100	5,100	6,300	100	6,100	5,000	5,300	
105	5,600	4,700	5,800	105	5,600	4,600	5,200	
110	4,900	4,400	5,300	110	5,100	4,200	5,000	
115	4,300	4,000	4,800	115	4,700	3,900	4,900	
120	3,700	3,700	4,100	120	4,400	3,600	4,700	
125	3,200	3,400	3,600	125	3,800	3,300	4,300	
130	2,700	3,200	3,000	130	3,400	3,000	3,900	
135	2,300	2,900	2,500	135	2,900	2,800	3,600	
140	1,900	2,700	2,100	140	2,500	2,600	3,400	
145	1,500	2,500		145	2,200	2,400	3,200	
150		2,300		150	1,800	2,200	3,000	
155				155	1,500	2,000	2,800	
160				160	1,200	1,800	2,600	
Telescoping mode	1	2	1	2	1	2	1	2

B: Load radius in feet

# WARNING AND OPERATING INSTRUCTIONS FOR LIFTING CAPACITIES

## GENERAL

1. RATED LIFTING CAPACITIES apply only to the machine as originally manufactured and normally equipped by TADANO LTD. Modifications to the machine or use of optional equipment other than that specified can result in a reduction of capacity.
2. Hydraulic cranes can be hazardous if improperly operated or maintained. Operation and maintenance of this machine must be in compliance with information, in the Operation Manual supplied with the crane. If this manual is missing, order a replacement through the distributor.
3. The operator and other personnel associated with this machine shall fully acquaint themselves with the latest American National Standards Institute (ANSI) safety standards for cranes.

## SET UP

1. Rated lifting capacities on the chart are the maximum allowable crane capacities and are based on the machine standing level on firm supporting surface under ideal job conditions. Depending on the nature of the supporting surface, it may be necessary to have structural supports under the outrigger floats or tires to spread the loads to a larger bearing surface.
2. For outrigger operation, outriggers shall be properly extended with tires free of supporting surface before operating crane.

## OPERATION

1. Rated lifting capacities have been tested to and meet minimum requirements of SAE J1063-Cantilevered Boom Crane Structures Method of Test.  
Rated lifting capacities do not exceed 85% of the tipping load on outriggers fully extended as determined by SAE J765-Crane Stability Test Code.
2. Rated lifting capacities for partially extended outriggers are determined from the formula, Rated Lifting Capacities = (Tipping Load - 0.1 × Tip Reaction) / 1.25.
3. Rated lifting capacities are based on actual load radius increased by boom deflection.
4. The weight of handling device such as hook blocks, slings, etc., must be considered as part of the load and must be deducted from the lifting capacities.
5. Rated lifting capacities are based on freely suspended loads and make no allowance for such factors as the effect of wind, sudden stopping of loads, supporting surface conditions, inflation of tires, operating speeds, side loads, etc. Side pull on boom or jib is extremely dangerous.  
Such action can damage the boom, jib or slewing mechanism, and lead to overturning of the crane.
6. Rated lifting capacities do not account for wind on lifted load or boom. We recommend against working under the condition that the load is out of control due to a strong wind. During boom lift, consider that the rated lifting capacity is reduced by 50% when the wind speed is 20 mph (9 m/s) to 27 mph (12 m/s); reduced by 70% when the wind speed is 27 mph (12 m/s) to 31 mph (14 m/s). If the wind speed is 31 mph (14 m/s) or over, stop operation. During jib lift, stop operation if the wind speed is 20 mph (9 m/s) or over.
7. Rated lifting capacities at load radius shall not be exceeded. Do not tip the crane to determine allowable loads.
8. Do not operate at boom lengths, radii, or boom angle, where no capacities are shown. Crane may overturn without any load on the hook.
9. When boom length is between values listed, refer to the rated lifting capacities of the next longer and next shorter booms for the same radius. The lesser of the two rated lifting capacities shall be used.
10. When making lifts at a load radius not shown, use the next longer radius to determine allowable capacity.
11. Load per line should not exceed 14,600 lbs. (6,600 kg) for main winch and auxiliary winch.
12. Check the actual number of parts of line with LOAD MOMENT INDICATOR (AML-E2) before operation. Maximum lifting capacity is restricted by the number of parts of line of LOAD MOMENT INDICATOR (AML-E2). Limited capacity is as determined from the formula, Single line pull for main winch 14,600 lbs. (6,600 kg) × number of parts of line.

13. The boom angle before loading should be greater to account for deflection. For rated lifting capacities, the loaded boom angle and the load radius is for reference only.
14. The 39.4' (12.0 m) boom length capacities are based on boom fully retracted. If not fully retracted [less than 53.7' (16.4 m) boom length], use the rated lifting capacities for the 53.7' (16.4 m) boom length.
15. Extension or retraction of the boom with loads may be attempted within the limits of the RATED LIFTING CAPACITIES.  
The ability to telescope loads is limited by hydraulic pressure, boom angle, boom length, crane maintenance, etc.  
For lifting capacity of single top, deduct the weight of the load handling equipment from the rated lifting capacity of the boom.
16. For the lifting capacity of single top, the net capacity shall not exceed 14,600 lbs. (6,600 kg) including the main boom hook mass attached to the boom.
17. When the base jib or top jib or both jibs are removed, set the jib state switch to the REMOVED position.
18. When erecting and stowing jib, be sure to retain it by hand or by other means to prevent its free movement.
19. Use "ANTI-TWOBLOCK" disable switch when erecting and stowing jib and when stowing hook block. While the switch is pushed, the hoist does not stop, even when overwind condition occurs.
20. When lifting a load by using jib (aux. winch) and boom (main winch) simultaneously, do the following:
  - Enter the operation status as jib operation, not as boom operation.
  - Before starting operation, make sure that mass of load is within rated lifting capacity for jib.
21. Before telescoping the boom, set the telescoping mode selector switch to mode 1 or mode 2 fully retracted.  
A change of the telescoping mode is not permissible when the boom has been partially or fully extended.
22. Crane operation is prohibited without full counterweight 9,600 lbs. (4.35 ton) installed. Outriggers shall be extended 23' 11-3 / 8" (7.3 m) spread when installing or removing removable counterweight.

## DEFINITIONS

1. Load Radius: Horizontal distance from a projection of the axis of rotation to supporting surface before loading to the center of the vertical hoist line or tackle with load applied.
2. Loaded Boom Angle: The angle between the boom base section and the horizontal, after lifting the rated lifting capacity at the load radius.
3. Working Area: Area measured in a circular arc about the centerline of rotation.
4. Freely Suspended Load: Load hanging free with no direct external force applied except by the hoist line.
5. Side Load: Horizontal side force applied to the lifted load either on the ground or in the air.

# GR-800XL-4 RATED LIFTING CAPACITIES (IN POUNDS)

COUNTERWEIGHT 9,600 lbs (4.35 t) ON RUBBER STATIONARY											
Over front					360° Rotation						
B	A	39.4' (12 m)	68.1' (20.8 m)	82.4' (25.1 m)	96.8' (29.5 m)	B	A	39.4' (12 m)	68.1' (20.8 m)	82.4' (25.1 m)	96.8' (29.5 m)
	10		65,500					10		38,200	
12		56,700				12		31,400			
15		46,800				15		20,900			
20		35,200	37,300	26,500		20		11,400	14,800	15,500	
25		22,900	26,100	26,200	26,000	25		6,300	9,500	10,200	10,600
30			19,000	19,600	19,700	30			6,200	6,800	7,200
35			14,400	14,900	15,300	35			3,900	4,500	4,800
40			11,100	11,600	11,900	40			2,200	2,800	3,200
45			8,600	9,100	9,500	45				1,500	1,900
50			6,700	7,200	7,500	50					
55			5,200	5,700	6,000	55					
60			4,000	4,400	4,700	60					
65				3,400	3,700	65					
70				2,600	2,900	70					
75				1,900	2,100	75					
80					1,500	80					
D		0°				20°					
Telescoping mode		1, 2	2	2	2	Telescoping mode		1, 2	2	2	2
2nd Boom		0	0	0	0	2nd Boom		0	0	0	0
3rd Boom		0	33	50	67	3rd Boom		0	33	50	67
4th Boom		0	33	50	67	4th Boom		0	33	50	67
Top Boom		0	33	50	67	Top Boom		0	33	50	67

COUNTERWEIGHT 9,600 lbs (4.35 t) ON RUBBER STATIONARY											
C	A	39.4' (12 m)		68.1' (20.8 m)		82.4' (25.1 m)					
	B	(12 m)	B	(20.8 m)	B	(25.1 m)					
0°		32.5	13,400	61.3	3,000	75.3	1,900				

C	A	39.4' (12 m)							
	B	(12 m)							
0°		32.5	3,700						

COUNTERWEIGHT 9,600 lbs (4.35 t) ON RUBBER CREEP									
Over front									
B	A	39.4' (12 m)	68.1' (20.8 m)	82.4' (25.1 m)	96.8' (29.5 m)				
	10		48,500						
12		41,800							
15		33,900							
20		24,900	27,100	26,500					
25		18,800	21,200	21,600	21,800				
30			17,000	17,400	17,600				
35			13,700	14,100	14,400				
40			11,100	11,600	11,800				
45			8,600	9,100	9,500				
50			6,700	7,200	7,500				
55			5,200	5,700	6,000				
60			4,000	4,400	4,700				
65				3,400	3,700				
70				2,600	2,900				
75				1,900	2,100				
80					1,500				
D		0°				20°			
Telescoping mode		1, 2	2	2	2				
2nd Boom		0	0	0	0				
3rd Boom		0	33	50	67				
4th Boom		0	33	50	67				
Top Boom		0	33	50	67				

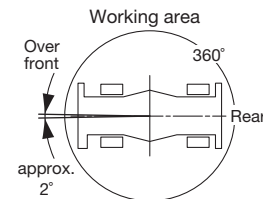

- A: Boom length in feet
- B: Load radius in feet
- C: Loaded boom angle (°)
- D: Minimum boom angle (°) for indicated length (no load)

NOTE: The lifting capacity data stored in the LOAD MOMENT INDICATOR (AML-E2) is based on the standard number of parts of line listed in the chart.  
Standard number of parts of line for on-rubber operation should be according to the chart.

COUNTERWEIGHT 9,600 lbs (4.35 t) ON RUBBER CREEP									
C	A	39.4' (12 m)		68.1' (20.8 m)		82.4' (25.1 m)			
	B	(12 m)	B	(20.8 m)	B	(25.1 m)			
0°		32.5	11,200	61.3	3,000	75.3	1,900		

Boom length in feet (meters)	39.4' (12 m)	42.0' to 96.8' (12 m to 29.5 m)	Single top jib
Number of parts of line	6	4	1



# WARNING AND OPERATING INSTRUCTIONS FOR ON RUBBER LIFTING CAPACITIES

- Rated lifting capacities on-rubber are in pounds and do not exceed 75% of tipping loads as determined by SAE J765-Crane Stability Test Code.
- Rated lifting capacities shown in the chart are based on condition that crane is set on firm level surfaces with suspension-lock applied. They are based on actual load radius increased by tire deformation and boom deflection.
- If the suspension-lock cylinders contain air, the axle will not be locked completely and rated lifting capacities may not be obtainable. Bleed the cylinders according to the operation safety and maintenance manual.
- Rated lifting capacities are based on proper tire inflation, capacity and condition. Damaged tires are hazardous to safe operation of crane.
- Tires shall be inflated to correct air pressure.

Tires	Air Pressure
29.5-25 34PR	57 psi. (400 kPa)

- Over front operation shall be performed within 2 degrees in front of chassis.
- On-rubber lifting with "jib" is not permitted. Maximum permissible boom length is 96.8 ft. (29.5 m).
- When making lift on-rubber stationary, set parking brake.
- For creep operation, boom must be centered over front of machine, slewing lock engaged, and load restrained from slewing. Travel slowly and keep the lifted load as close to the ground as possible, and especially avoid any abrupt steering, accelerating or braking.
- Do not operate the crane while carrying the load.
- Creep is motion for crane not to travel more than 200 ft. (60 m) in any 30 minute period and to travel at the speed of less than 1 mph (1.6 km/h).
- For creep operation, choose the drive mode and proper gear according to the road or working condition.

## NOTES FOR LOAD MOMENT INDICATOR (AML-E2)

- Set AML select keys in accordance with the actually operating crane conditions and don't fail to make sure, before crane operation, that the displays on front panel are correct.
- When operating crane on outriggers:
  - Set "P.T.O." switch to "ON".
  - Press the outrigger state select key to register for the outrigger operation. If the display agrees with the actual state, press the set key to register. After the completion of the registration, the display returns to the crane operation status.
  - Press the lift state select key to register the lift state to be used (single top/jib/boom).
  - Each time the lift state select key is pressed, the display changes. If the display agrees with the actual state, press the set key to register. After the completion of the registration, the display returns to the crane operation status.
  - When erecting and stowing jib, select the status of jib set (Jib state indicative symbol lights up).
- When operating crane on-rubber:
  - Set "P.T.O." switch to "ON".
  - Press the outrigger state select key to register for the on-rubber operation. Each time the outrigger state select key is pressed, the display changes. Select the creep operation, the on-rubber state indicator symbol lights up.
  - Press the lift state select key to register the lift state. However, pay attention to the following.
    - For stationary operation.
      - The front capacities are attainable only when the over front position symbol comes on.
    - When the boom is more than 2 degrees from centered over front of chassis, 360° capacities are in effect.
    - When a load is lifted in the front position and then slewed to the side area, make sure the value of the LOAD MOMENT INDICATOR (AML-E2) is below the 360° lifting capacity.
  - For creep operation.
    - The creep capacities are attainable only when boom is in the straight forward position of chassis and the over front position symbol is on. If boom is not in the straight forward position of chassis, never lift load.
- This machine is equipped with an automatic slewing stopping device. (For the details, see Operation Manual.) But, operate very carefully because the automatic slewing stop does not work in the following cases.
  - During on-rubber operation.
  - When the "P.T.O." switch is set to "OVERRIDE" and the "OVERRIDE" key switch outside the cab is on.
- During crane operation, make sure that the displays on front panel are in accordance with actual operating conditions.
- The displayed values of LOAD MOMENT INDICATOR (AML-E2) are based on freely suspended loads and make no allowance for such factors as the effect of wind, sudden stopping of loads, supporting surface conditions, inflation of tire, operating speed, side loads, etc. For safe operation, it is recommended when extending and lowering boom or slewing, lifting loads shall be appropriately reduced.
- LOAD MOMENT INDICATOR (AML-E2) is intended as an aid to the operator. Under no condition should it be relied upon to replace use of capacity charts and operating instruction. Sole reliance upon LOAD MOMENT INDICATOR (AML-E2) aids in place of good operating practice can cause an accident. The operator must exercise caution to assure safety.
- The lifting capacity differs depending on the outrigger extension width and slewing position. Work with the capacity corresponding to the outrigger extension width and slewing position. For the relationship among the outrigger extension width, slewing position and lifting capacities, refer to the working area charts.

## GR-800XL-4 AXLE WEIGHT DISTRIBUTION CHART

	Pounds			Kilograms		
	GVW	Front	Rear	GVW	Front	Rear
Base machine	99,800	54,960	44,840	45,270	24,930	20,340
Remove:						
1. 7.3 ton (6.6 metric ton) hook block	-360	-550	190	-165	-251	86
2. 80 ton (72.6 metric ton) hook block	-1,200	-2,200	1,010	-540	-998	458
3. Top jib	-740	-990	250	-336	-450	114
4. Base jib	-1,910	-3,760	1,850	-867	-1,704	837
5. Counterweight	-9,600	4,240	-13,830	-4,350	1,924	-6,274



**TADANO AMERICA CORPORATION**

4242 West Greens Road.  
Houston, Texas, 77066 U.S.A.  
PHONE: (281) 869-0030  
FAX: (281) 869-0040  
<http://www.tadanoamerica.com>